

Licensing Sub-Committee

Tuesday 3 October 2017 at 10.00 am

To be held at the Town Hall, Pinstone Street, Sheffield, S1 2HH

The Press and Public are Welcome to Attend

Membership

Councillors David Barker (Chair), Andy Bainbridge and Andy Nash
Cliff Woodcraft (Reserve)

PUBLIC ACCESS TO THE MEETING

The Licensing Committee carries out a statutory licensing role, including licensing for taxis and public entertainment.

As a lot of the work of this Committee deals with individual cases, some meetings may not be open to members of the public.

Recording is allowed at Licensing Committee meetings under the direction of the Chair of the meeting. Please see the website or contact Democratic Services for details of the Council's protocol on audio/visual recording and photography at council meetings.

A copy of the agenda and reports is available on the Council's website at www.sheffield.gov.uk. You can also see the reports to be discussed at the meeting if you call at the First Point Reception, Town Hall, Pinstone Street entrance. The Reception is open between 9.00 am and 5.00 pm, Monday to Thursday and between 9.00 am and 4.45 pm. on Friday.

You may not be allowed to see some reports because they contain confidential information. These items are usually marked * on the agenda.

If you require any further information please contact Harry Clarke on 0114 273 6183 or email harry.clarke@sheffield.gov.uk.

FACILITIES

There are public toilets available, with wheelchair access, on the ground floor of the Town Hall. Induction loop facilities are available in meeting rooms.

Access for people with mobility difficulties can be obtained through the ramp on the side to the main Town Hall entrance.

**LICENSING SUB-COMMITTEE AGENDA
3 OCTOBER 2017**

Order of Business

- 1. Welcome and Housekeeping Arrangements**
- 2. Apologies for Absence**
- 3. Exclusion of Public and Press**
To identify items where resolutions may be moved to exclude the press and public
- 4. Declarations of Interest**
Members to declare any interests they have in the business to be considered at the meeting
- 5. Hackney Carriage and Private Hire Licensing - Individual Cases***
Report of the Chief Licensing Officer
- 6. Local Government (Miscellaneous Provisions) Act 1982 - Schools (Ice Cream) Street Trading Consent**
Report of the Chief Licensing Officer
- 7. Local Government (Miscellaneous Provisions) Act 1982 - City Centre Street Trading Consent**
Report of the Chief Licensing Officer

*(NOTE: The report at item 5 in the above agenda is not available to the public and press because it contains exempt information described in paragraphs 1 and 2 of Schedule 12A to the Local Government Act 1972 (as amended))

This page is intentionally left blank

ADVICE TO MEMBERS ON DECLARING INTERESTS AT MEETINGS

If you are present at a meeting of the Council, of its executive or any committee of the executive, or of any committee, sub-committee, joint committee, or joint sub-committee of the authority, and you have a **Disclosable Pecuniary Interest (DPI)** relating to any business that will be considered at the meeting, you must not:

- participate in any discussion of the business at the meeting, or if you become aware of your Disclosable Pecuniary Interest during the meeting, participate further in any discussion of the business, or
- participate in any vote or further vote taken on the matter at the meeting.

These prohibitions apply to any form of participation, including speaking as a member of the public.

You **must**:

- leave the room (in accordance with the Members' Code of Conduct)
- make a verbal declaration of the existence and nature of any DPI at any meeting at which you are present at which an item of business which affects or relates to the subject matter of that interest is under consideration, at or before the consideration of the item of business or as soon as the interest becomes apparent.
- declare it to the meeting and notify the Council's Monitoring Officer within 28 days, if the DPI is not already registered.

If you have any of the following pecuniary interests, they are your **disclosable pecuniary interests** under the new national rules. You have a pecuniary interest if you, or your spouse or civil partner, have a pecuniary interest.

- Any employment, office, trade, profession or vocation carried on for profit or gain, which you, or your spouse or civil partner undertakes.
- Any payment or provision of any other financial benefit (other than from your council or authority) made or provided within the relevant period* in respect of any expenses incurred by you in carrying out duties as a member, or towards your election expenses. This includes any payment or financial benefit from a trade union within the meaning of the Trade Union and Labour Relations (Consolidation) Act 1992.

*The relevant period is the 12 months ending on the day when you tell the Monitoring Officer about your disclosable pecuniary interests.

- Any contract which is made between you, or your spouse or your civil partner (or a body in which you, or your spouse or your civil partner, has a beneficial interest) and your council or authority –
 - under which goods or services are to be provided or works are to be executed; and
 - which has not been fully discharged.

- Any beneficial interest in land which you, or your spouse or your civil partner, have and which is within the area of your council or authority.
- Any licence (alone or jointly with others) which you, or your spouse or your civil partner, holds to occupy land in the area of your council or authority for a month or longer.
- Any tenancy where (to your knowledge) –
 - the landlord is your council or authority; and
 - the tenant is a body in which you, or your spouse or your civil partner, has a beneficial interest.
- Any beneficial interest which you, or your spouse or your civil partner has in securities of a body where -
 - (a) that body (to your knowledge) has a place of business or land in the area of your council or authority; and
 - (b) either -
 - the total nominal value of the securities exceeds £25,000 or one hundredth of the total issued share capital of that body; or
 - if the share capital of that body is of more than one class, the total nominal value of the shares of any one class in which you, or your spouse or your civil partner, has a beneficial interest exceeds one hundredth of the total issued share capital of that class.

If you attend a meeting at which any item of business is to be considered and you are aware that you have a **personal interest** in the matter which does not amount to a DPI, you must make verbal declaration of the existence and nature of that interest at or before the consideration of the item of business or as soon as the interest becomes apparent. You should leave the room if your continued presence is incompatible with the 7 Principles of Public Life (selflessness; integrity; objectivity; accountability; openness; honesty; and leadership).

You have a personal interest where –

- a decision in relation to that business might reasonably be regarded as affecting the well-being or financial standing (including interests in land and easements over land) of you or a member of your family or a person or an organisation with whom you have a close association to a greater extent than it would affect the majority of the Council Tax payers, ratepayers or inhabitants of the ward or electoral area for which you have been elected or otherwise of the Authority's administrative area, or
- it relates to or is likely to affect any of the interests that are defined as DPIs but are in respect of a member of your family (other than a partner) or a person with whom you have a close association.

Guidance on declarations of interest, incorporating regulations published by the Government in relation to Disclosable Pecuniary Interests, has been circulated to you previously.

You should identify any potential interest you may have relating to business to be considered at the meeting. This will help you and anyone that you ask for advice to fully consider all the circumstances before deciding what action you should take.

In certain circumstances the Council may grant a **dispensation** to permit a Member to take part in the business of the Authority even if the member has a Disclosable Pecuniary Interest relating to that business.

To obtain a dispensation, you must write to the Monitoring Officer at least 48 hours before the meeting in question, explaining why a dispensation is sought and desirable, and specifying the period of time for which it is sought. The Monitoring Officer may consult with the Independent Person or the Council's Audit and Standards Committee in relation to a request for dispensation.

Further advice can be obtained from Gillian Duckworth, Director of Legal and Governance on 0114 2734018 or email gillian.duckworth@sheffield.gov.uk.

This page is intentionally left blank

By virtue of paragraph(s) 1, 2 of Part 1 of Schedule 12A
of the Local Government Act 1972.

Document is Restricted

This page is intentionally left blank



SHEFFIELD CITY COUNCIL Committee Report

Report of: Chief Licensing Officer, Head of Licensing

Date: 3rd October 2017 at 10.45 am

Subject: Street Trading
Application for a Schools (Ice Cream) Street Trading

Author of Report: Claire Bower

Summary: To consider an application for a Schools (Ice Cream) Street Trading consent at Birley Community Primary School, Thornbridge Avenue.

Background Papers: As attached

Category of Report: OPEN

**REPORT OF THE CHIEF LICENSING OFFICER,
HEAD OF LICENSING TO THE LICENSING SUB COMMITTEE**

REF No: 122/17

LOCAL GOVERNMENT (MISCELLANEOUS PROVISIONS) ACT 1982

SCHOOLS (ICE CREAM) STREET TRADING – Paul Chafer

1.0 PURPOSE OF REPORT

- 1.1 To consider an application for the grant of a Schools (Ice Cream) Street Trading consent to trade at Birley Community Primary School, Thornbridge Avenue, Sheffield.

2.0 INTRODUCTION

- 2.1 The Council as a Licensing Authority have power under the provision of the 1982 Act to regulate Street Trading in the City.
- 2.2 A Street Trading Consent is required to trade on any Street (which includes roads, footways, forecourts, or other areas to which the public have access) within the Sheffield City Boundary.
- 2.3 The Licensing Committee at it's meeting of 29th January 2002 passed the following resolution:
1. That under the provisions of schedule 4 of the Local Government (Miscellaneous Provisions) Act 1982:
 - (a) all streets (which includes roads, footways, forecourts or other areas to which the public have access) within the Sheffield City boundary, shall be designated consent streets and;
 - (b) such street trading designation shall take effect as from the 1st April 2002; and
 - (c) all previous designations in relation to street trading will be rescinded as a result of the designation set out above.
 2. The effect of this resolution is that from 1st April 2002, it will be an offence to engage in street trading in any street or any other place identified in the above resolution without being authorised to do so by consent from the City Council.
- 2.4 A Local Authority may attach conditions to a Street Trading Consent. The conditions may include conditions to prevent obstruction of the street and danger to persons using the street or nuisance or annoyance.
- 2.5 A Street Trading Consent may only be granted for a maximum period of twelve months.

- 2.6 There is no appeal procedure against the refusal or revocation of any consent. An applicant may, however apply for judicial review of the Council's decision.

3.0 THE APPLICATION

- 3.1 The applicant is a Mr Paul Grayson a copy of the application is attached at Appendix 'A'.
- 3.2 The application was submitted on 4th May 2017.
- 3.3 The application is to sell ice cream near the entrance of Birley Community Primary School during school term times. A photo of the area where the van would be parked, if granted, is attached at Appendix 'B'.
- 3.4 Mr Grayson submitted, as part of his application, a 39 page petition of signatures of people who would like to allow an ice cream van outside the school. Due to the size of the document, it has not been attached to the report but will be available for Members to view at the Hearing.
- 3.5 The application was circulated, in the usual manner, to South Yorkshire Police, South Yorkshire Fire and Rescue, Highways and Planning and no adverse comments were received.

4.0 REASONS FOR REFERRAL

- 4.1 The application has been referred to the Sub-Licensing Committee for their consideration as the Licensing Authority has received an objection to the application from the Headteacher of the school.
- 4.2 A copy of the objection is attached at Appendix 'C'
- 4.3 The objections refer to issues contained in section 2.8 of our street trading policy when determining the application, and Members are referred to in particular section 2.8.2: Public Safety/Highway.
- 4.4 Members should consider all the information provided by the applicant both in their written application and in person at the hearing.
- 4.5 The applicant and objector have been invited to attend the Licensing Committee hearing. Copies of the invites are attached at Appendix 'D'.
- 4.6 A copy of the hearing procedure is attached at Appendix 'E'.

5.0 FINANCIAL IMPLICATIONS

- 5.1 The Street Trading Policy states that fees will be set and reviewed annually on a full cost recovery basis. The level of fee takes into account the location, duration of consent, the trading hours and articles to be sold as well as the enforcement of terms and conditions.

5.2 The fees for a school's (ice cream) street trading consent is currently fixed at £50 and is payable on application. Therefore there are no financial implications arising from this report.

6.0 RECOMMENDATIONS

6.1 That Members consider all the relevant information available, any representations that may be made and our policy.

7.0 OPTIONS OPEN TO THE COMMITTEE

7.1 To grant the application for a School's (Ice Cream) Street Trading Consent at the location applied for.

7.2 To grant the application with amendments.

7.3 To defer the matter for further consideration.

7.4 To refuse the grant of the Street Trading Consent.

Steve Lonnia
Head of Licensing
Block C Staniforth Road
Staniforth Road
Sheffield
S9 3HD

20th September 2017

Appendix A

Application Form

Local Government (Miscellaneous Provisions) Act 1982

Application for a School Street Trading Consent

LICENSING

Notes to Applicant

All questions must be answered unless otherwise stated.
If relevant questions are not answered, the application will be deemed incomplete and returned to the Applicant.

SERVICES

1) **TWO HEREBY APPLY** to the Sheffield City Council for the grant of a school street trading consent to sell ice cream (delete as appropriate).

A. THE APPLICANT(S)

		1 st Applicant (Mr/Mrs/Miss/other)	2 nd Applicant (Mr/Mrs/Miss/other)
Q1	Full names of the applicant	Pauline D. ...	
Q2	Applicant's permanent home address	[REDACTED]	
Q3	Date of birth	[REDACTED]	
Q4	Nationality and place of birth	[REDACTED]	
Q5	National Insurance No.	[REDACTED]	
Q6	Do you have the legal right to work and live in the UK?	<input checked="" type="checkbox"/> YES / NO Details:	<input type="checkbox"/> YES / NO Details:
Q7	Have you ever been refused a street trading consent in this or any other area?	<input checked="" type="checkbox"/> YES / NO Details:	<input type="checkbox"/> YES / NO Details:
Q8	Telephone No.	[REDACTED]	
Q9	Email address	[REDACTED]	
Q10	Current ice cream mobile consent number		

B. COMPANY DETAILS (if applying as a Corporate body)

Q11	Name	...
Q12	Registered address	...
Q13	Registered number	...
Q14	Telephone number	...
Q15	Email address	...
Q16	Please provide details of all Directors (names, addresses, dates of birth and details of any convictions). A separate sheet may be used.	...

C. THE VEHICLE

Q17	Description of vehicle to be used	...
Q18	Registration number	...
Q19	Date of first registration	...
Q20	Last MOT and service	...
Q21	Size of vehicle	Height: ... Width: ... Length: ...
Q22	Items to be sold	...
Q23	Does the vehicle meet the quality criteria? Your vehicle will be inspected prior to granting a permit	...

D. THE SCHOOL

Q24	Name and address of school where you wish to trade	...
Q25	Location of pitch (include site plan)	...

E. CONVICTIONS / CAUTIONS

Q26 Have any of the applicants ever been convicted of a criminal offence, whether in the United Kingdom or elsewhere?

Applicant 1 Yes [] No []

Applicant 2 Yes [] No []

If the answer is Yes please give full details below:

Details of previous convictions and/or cautions

Date of Conviction	Court of Conviction	Nature of Offence	Sentence
Applicant 1	Conviction Details will be available for Members at the Hearing		
Applicant 2			

F. CHECK LIST

The following documents must be attached with this application: (tick)

The appropriate fee	<input checked="" type="checkbox"/>
Your current passport	<input checked="" type="checkbox"/>
Your current drivers licence	<input checked="" type="checkbox"/>
One other proof of identity (showing your name and current address (recent utility bill, bank statement etc)	<input checked="" type="checkbox"/>
Right to work documentation (if applicable)	<input checked="" type="checkbox"/>
Two colour (recent and identical) passport size photographs signed and dated on the reverse as a true likeness	<input checked="" type="checkbox"/>
Head Teachers written consent	<input checked="" type="checkbox"/>
If trading from private land, written confirmation from the landowner	<input checked="" type="checkbox"/>
Ordnance survey map of at least 1:1250 scale clearly identify the proposed trading position	<input checked="" type="checkbox"/>
Photographs of the vehicle / unit showing front, side and rear	<input checked="" type="checkbox"/>
Details of any food hygiene qualifications	<input checked="" type="checkbox"/>
Confirmation that the business has a food hygiene score rating of 3 or more	<input checked="" type="checkbox"/>
Ensure your vehicle meets the qualitative criteria	<input checked="" type="checkbox"/>
Any further information you may wish to submit in support of your application	<input checked="" type="checkbox"/>

The following documents must be forwarded to us before the grant of your consent:

(tick if enclosed with this application)

Certificate of insurance in respect of the vehicle (tick)

Appropriate vehicle test (tick)

Public liability insurance (minimum of £3,000,000) (tick)

Written confirmation that the vehicle meets the Council's food safety standards (tick)

Waste management contract (tick)

Declare that you have registered as a food business (tick)

G. DECLARATION

WARNING

Paragraph 10(3) of Schedule 4 to the Local Government (Miscellaneous Provisions) Act 1980 gives the following warning:

'Any person who, in connection with an application for a street trading consent, makes a false statement which he knows to be false, in any material respect, or which he does not believe to be true, shall be guilty of an offence.'

I/We

- declare that all the information I have given in this application is complete and correct
- declare that I am over 17 years of age (in cases of individual applicants)
- declare I understand and will comply with the Sheffield City Council Street Trading Consent Conditions
- undertake to pay Sheffield City Council the relevant consent fee in advance whether demanded or not
- understand that consents are not transferable
- understand that the Local Authority reserve the right to make further enquiries with South Yorkshire Police as a result of this application as they may consider desirable, and
- understand that giving false information is an offence and may result in prosecution and/or a street trading consent being refused or revoked

Applicant 1

Signature

Print name

Date

Capacity

Applicant 2

Signature

Print name

Date

Capacity

Appendix B

Location Plan

04/27/17

17 Thornbridge Ave - 10401 St

17 Thornbridge Ave



Google Maps - 421143 - © 2017 Google

04/27/17, England

04/27/17, 10401 St

Hadley Community
Primary School



Appendix C

Objection

From: Dawn McAughey [<mailto:dawnmcaughey@birleyprimaryacademy.co.uk>]
Sent: 19 September 2017 13:19
To: licensingservice
Subject: Objection to licence to trade

I wish to raise an objection to the licence for the ice cream van to trade outside Birley Primary Academy. This is due to the numerous complaints I have received over recent years about the van adding considerably to the congestion at the end of the school day on what is already a very busy road. Safety of all pupils in school is paramount.

Thanks

Dawn McAughey

Dawn McAughey
Headteacher
Birley Primary Academy
01142399007
dawnmcaughey@birleyprimaryacademy.co.uk

Appendix D

Invitations to Attend Hearing

LOCAL GOVERNMENT MISCELLANEOUS PROVISIONS ACT 1982

Street Trading – Schools (Ice Cream) Street Trading Consent – Birley Community Primary

IMPORTANT: NOTIFICATION OF A COMMITTEE MEETING

To: Mr Paul Grayson

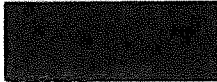

Email:

LEGISLATION: Local Government (Miscellaneous Provisions) Act 1982

LICENCE TYPE: Schools (Ice Cream) Street Trading Consent – Birley Community Primary

I refer to the above and the application for the grant of a street trading consent.

This matter has been referred to the Licensing Committee of Sheffield City Council for determination. Full details will be provided in the report to the Committee which will be sent to you in due course. The Licensing Committee has the authority to decide what action to take in relation to each application.

The Committee has indicated that it expects applicants, interested parties and any objectors to attend the meeting.

The meeting in respect of the application will take place on **Tuesday 3rd October 2017** in a Committee Room of the Town Hall, Sheffield, S1 2HH (Pinstone Street entrance) and you are invited to attend at **10.45 am**.

PLEASE NOTE:

I would be grateful if you could confirm that you will be attending the meeting by telephoning the Licensing Office on 0114 2734264.

Steve Lonnia
Chief Licensing Officer
Head of Licensing

Date: 21st September 2017

IMPORTANT: A DECISION IS LIKELY TO BE MADE ON THIS ISSUE WHETHER YOU MAKE REPRESENTATION OR NOT.

Licensing Service, Business Strategy and Regulation, Block C Staniforth Road Depot, Staniforth Road, Sheffield, S9 3HD Telephone 0114 2734264

The Licensing Service Reception is open from 10.00am to 4.00pm, Monday to Friday. Telephone calls can be taken from 09:00am to 5:00pm.

LOCAL GOVERNMENT MISCELLANEOUS PROVISIONS ACT 1982

Street Trading – Schools (Ice Cream) Street Trading Consent – Birley Community Primary

IMPORTANT: NOTIFICATION OF A COMMITTEE MEETING

To: Ms Dawn McAughey
Headteacher
Birley Primary Academy

Email: dawnmcaughey@birleyprimaryacademy.co.uk

LEGISLATION: Local Government (Miscellaneous Provisions) Act 1982

LICENCE TYPE: Schools (Ice Cream) Street Trading Consent – Birley Community Primary

I refer to the above and your recent objection to the application for the grant of a street trading consent.

This matter has been referred to the Licensing Committee of Sheffield City Council for determination. Full details will be provided in the report to the Committee which will be sent to you in due course. The Licensing Committee has the authority to decide what action to take in relation to each application.

The Committee has indicated that it expects applicants, interested parties and any objectors to attend the meeting.

The meeting in respect of the application will take place on **Tuesday 3rd October 2017** in a Committee Room of the Town Hall, Sheffield, S1 2HH (Pinstone Street entrance) and you are invited to attend at **10.45 am**.

PLEASE NOTE:

I would be grateful if you could confirm that you will be attending the meeting by telephoning the Licensing Office on 0114 2734264.

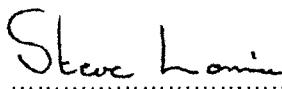
.....

Steve Lonnia
Chief Licensing Officer
Head of Licensing

Date: 21st September 2017

IMPORTANT: A DECISION IS LIKELY TO BE MADE ON THIS ISSUE WHETHER YOU MAKE REPRESENTATION OR NOT.

Licensing Service, Business Strategy and Regulation, Block C Staniforth Road Depot,
Staniforth Road, Sheffield, S9 3HD Telephone 0114 2734264

The Licensing Service Reception is open from 10.00am to 4.00pm, Monday to Friday. Telephone calls can be taken from 09:00am to 5:00pm.

Appendix E

Hearing Procedure

STREET TRADING CONSENT APPLICATION SUB-COMMITTEE HEARING PROCEDURE

This procedure has been drawn up to assist those parties attending Street Trading Consent Committee hearings.

1. The Chair of the Licensing Committee will introduce the Committee and ask officers to introduce themselves.
2. The Chair will ask the applicants and interested parties to formally introduce themselves.
3. The Solicitor to the Committee will outline the procedure to be followed at the hearing.
4. Hearing Procedure:-
 - (a) The Licensing Officer will introduce the report.
 - (b) Questions concerning the report can be asked both by Members and the applicant.
 - (c) The applicant/consent holder (or his/her nominated representative) will then be asked to:-
 - (i) detail the application;
 - (ii) provide clarification on the application and respond to the representations made.
 - (d) The Chair of the Licensing Committee will invite Members of the Sub-Committee and all other parties present to put any relevant questions to the applicant and/or his/her representative.
 - (e) Consultees / interested parties will be invited to present their representations or elect a spokesperson (which may be a Councillor) to speak on their behalf. New representations must not be raised.
 - (f) The Chair of the Licensing Committee will invite Members of the Sub-Committee and all other parties present to put any relevant questions to the consultees / interested parties.
 - (g) The consultees / interested parties will be invited to sum up. A maximum of 5 minutes will be allowed.
 - (h) The applicant will be invited to sum up. A maximum of 5 minutes will be allowed.
 - (i) The Licensing Officer will then detail the options.
 - (j) There will then be a private session for Members to take legal advice and consider the application.
 - (k) Once a decision has been reached, all parties will be invited to return. The Sub-Committee's decision and reasons will be announced by the Chair.
 - (l) The Sub-Committee's decision will be confirmed in writing to the applicant and those parties who made representations.

- NB:
- 1) At any time in the Licensing Process Members of the Committee may request legal advice from the Solicitor to the Committee. This advice may be given in open session or in private.
 - 2) The Committee Hearing will be held in public unless and in accordance with the Regulations the Committee determine that the public should be excluded.

There is no right of appeal against the Council's decision to refuse to grant or revoke a Street Trading Consent



SHEFFIELD CITY COUNCIL Committee Report

Report of: Chief Licensing Officer, Head of Licensing

Date: 3rd October 2017 at 11.30am

Subject: Street Trading
Application for a City Centre Street Trading Consent

Author of Report: Stephen Lonnia

Summary: To consider an application for the grant of a City Centre Street Trading Consent to trade on Fargate.

Background Papers: As attached
Street Trading Policy

Category of Report: OPEN

**REPORT OF CHIEF LICENSING OFFICER, HEAD OF LICENSING,
TO THE LICENSING COMMITTEE**

LOCAL GOVERNMENT (MISCELLANEOUS PROVISIONS) ACT 1982

City Centre Street Trading (Fargate) – No Meat Today Ltd - Vegan Food

Ref: 123/17

1.0 PURPOSE OF REPORT

1.1 To consider an application for the grant of a City Centre Street Trading Consent to trade on Fargate.

2.0 INTRODUCTION

2.1 The Council have power under the provision of the 1982 Act to regulate street trading in the city.

2.2 A Street Trading Consent is required to trade on any street (which includes roads, footways, forecourts, or other areas to which the public have access) within the Sheffield City Boundary.

2.3 The Licensing Committee at it's meeting of 29th January 2002 passed the following resolution:

1. That under the provisions of schedule 4 of the Local Government (Miscellaneous Provisions) Act 1982:
 - (a) all streets (which includes roads, footways, forecourts or other areas to which the public have access) within the Sheffield City boundary, shall be designated consent streets and;
 - (b) such street trading designation shall take effect as from the 1st April 2002; and
 - (c) all previous designations in relation to street trading will be rescinded as a result of the designation set out above.
2. The effect of this resolution is that from 1st April 2002, it will be an offence to engage in street trading in any street or any other place identified in the above resolution without being authorised to do so by consent from the City Council.

2.4 A Local Authority may attach conditions to a Street Trading Consent. The conditions may include conditions to prevent obstruction of the street and danger to persons using the street or nuisance or annoyance.

2.5 A Street Trading Consent may only be granted for a maximum period of twelve months.

2.6 There is no appeal procedure against the refusal or revocation of a consent. An applicant may, however apply for judicial review of the Council's decision.

2.7 A copy of the Council's Street Trading Policy will be forwarded to Members prior to the Meeting, a copy of which will also be available on the day.

3.0 CITY CENTRE STREET TRADING

- 3.1 Working in partnership with the City Centre Management Team and Planning, Licensing presented a report to Committee in August 2011 to encourage more local businesses to trade in the city centre whilst also controlling the type and thereby controlling the quality that is on offer.
- 3.2 This is to encourage more local businesses to trade in the city centre and to offer a more continental style of trading in certain areas of the city centre
- 3.3 There is no constraint on the type of goods that can be sold. However, we would like to encourage more traditional goods that would give a more continental style to the City Centre.
- 3.4 A City Centre Qualitative Criteria for Small Trading Stalls was approved to meet these requirements (attached at Appendix 'A').
- 3.5 The fee for consent has been set at £498.50 per quarter (£1,994 per annum) to trade seven days a week between 7am and 7pm.

4.0 THE APPLICATION

- 4.1 An application has been submitted by 'No Meat Today Ltd' on the 14th August 2017 to sell vegan food on Fargate in the city centre. A copy of the application and supporting documentation is attached at Appendix 'B'.
- 4.2 Members are to note the applicant has specified a preferred site which is currently taken by another street trader. This site is referred to as the 'top of fargate' as listed in the below table, the applicant is however open to be sited elsewhere if unable to obtain preferred site. Specific location of site will need to be agreed in conjunction with the City Centre Management Team and the Planning Department.
- 4.3 A number of pitches have been allocated for city centre street trading at a previous meeting, and majority of them have been taken by other Street Traders as detailed below:

Area	Items sold	Consent Free/Taken
Top of Fargate	Sausages, Chips, salad, drinks	Taken
Bottom of Fargate	Ice-cream	Taken
Fargate (granted outside policy numbers)	Pancakes (previously flowers)	Taken
Howard Street	Hot Drinks and sweets	Taken
Devonshire Green	Tea, Coffee and Cake	Taken
Barkers Pool	Burgers, hotdogs, chips etc	Taken
Tudor Square		Free

- 4.3 Members are to also note that there are currently two further applications pending for Fargate which have been deferred by the Licensing Sub-Committee.

4.4 The application was circulated, in the usual manner, to South Yorkshire Police, South Yorkshire Fire and Rescue, Highways and Planning, and City Centre Management.

4.5 No objections have been received.

5.0 REASONS FOR REFERRAL

5.1 The application has been referred to the Licensing Sub-Committee for two reasons

1. Section 3.1.13 of Sheffield's Street Trading Policy refers that all applications for city centre street trading are to be placed before our Licensing Sub-Committee for determination.
2. The applicant is requesting the grant of a street trading consent on Fargate which will be outside the agreed policy numbers of consents in that area.

5.2 Each application must be determined on its own individual merits and Members should consider all information provided by the applicant both in their written application and in person at the meeting.

5.3 The applicant has been invited to attend the Licensing Sub-Committee meeting. A copy of the invite is attached at Appendix 'C'.

5.4 A copy of the hearing procedure is attached at Appendix 'D'.

6.0 FINANCIAL IMPLICATIONS

6.1 There are no financial implications for the Council arising from this report. Street Trading fees are set and reviewed annually on a full cost recovery basis. The level of fee takes into account the location, duration of consent, the trading hours and articles to be sold as well as the enforcement of the terms and conditions.

7.0 RECOMMENDATIONS

7.1 That Members consider all relevant information provided by the applicant both in their written application and in person at the meeting and against Sheffield's Street Trading Policy.

8.0 OPTIONS OPEN TO THE COMMITTEE

8.1 To grant the application for a Static Street Trading Consent at location applied for.

8.2 To grant the application with amendments (which includes an alternative location).

8.3 To defer the matter for further consideration.

8.4 To refuse the grant of the Static Street Trading Consent

Steve Lonnia
Chief Licensing Officer & Head of Licensing
Business Strategy and Regulation, Place Portfolio
Block C Staniforth Road Depot
Staniforth Road, Sheffield S9 3HD

20th September 2017

APPENDIX 'A'

CITY CENTRE QUALITATIVE CRITERIA

CITY CENTRE STREET TRADING Small Trading Stalls

BACKGROUND

Street activities are an essential ingredient of a vibrant and lively city, and in Sheffield there is a strong demand for legitimate small scale trading pitches. They also offer an opportunity for small businesses to get started with relatively modest outlay.

The widening of footways offers the opportunity to designate more pitches in locations that will add to the attractiveness of the City Centre. In Orchard Square and Meadowhall 'Barrow' style stalls are used extensively, enhancing the colour and vitality of those places.

This scheme is part of the City Council's campaign to make Sheffield City Centre a more attractive and vibrant place. Set out below is the qualitative criteria which forms the basis on which to test applications for the grant of designated small trading stall Street Trading Consent sites within the City Centre.

QUALITATIVE CRITERIA – SMALL TRADING STALLS

GENERAL DESIGN

- There will be no motorised vehicles or stalls etc. permitted as part of this scheme.
- All barrows/handcarts must be capable of being moved on and off site by hand and any vehicles used to bring the barrows/handcarts to the site must be parked, loaded and unloaded off site.
- Good display is an important part of the selling process and top quality presentation encourages purchase and benefits the retailer reputation.
- It is in the best interest of traders to produce a high quality design in their barrows/handcarts. The function of the stall is to identify the trader and add vitality and colour to the immediate area, and reflect the quality, cleanliness and order in their operation. The barrow/stall contributes to the appearance of the street for good or bad, so design matters to everyone who uses the street, as well as the operator.
- Sign writing and scrollwork must be finished to a standard acceptable to the City Council.
- The unit must be visually acceptable to the City Council (this will include the Head of Licensing, City Centre Manager and Planning Service) and be in keeping with the street/area that it is to be located.
- Advertisements on stalls will not be permitted except by permission of the Council in writing and subject to further conditions. The Council shall be the sole judge of what is an acceptable advertisement.
- The Council will reserve the right to not renew any consent where it considers the product(s) offered by the operator are not in keeping with the requirements of the site and the promotion of the City Centre.
- Non functional elements attached to barrows / handcarts, are not acceptable.

- The general design of the barrow/handcart must meet the requirements of the Council for that location.
- Flame retardant 'skirts' are to be used if necessary, so as to obscure the frame, gas bottle etc. They should be designed to 'unify' the barrow/handcart.
- All equipment, tools, gas bottles etc. must be self contained within the stall/handcart etc.
- Bright colours and a sense of fun are encouraged.
- Finished in flame retardant paint.
- A colour photograph or scale illustration of the proposed handcart must be submitted to the Licensing Service as part of the application process.
- No barrow/handcart should have a frontage greater than 3.0 metres or a width greater than 2.0metre.
- Roofs should be no more than 2.5m above ground level.
- Pitched and curved roofs are encouraged.
- Canopies should be high quality with a feeling of 'permanence'. These could be manufactured from either stretched canvas, or woven material, opaque or light metal materials. Clear plastic awning and extensions to the canopy will not be acceptable.
- Canopies must be maintained and cleaned to a high standard.
- Food traders must ensure that any stall design satisfies the requirement of food safety legislation. Staff must be adequately trained in good hygiene (Basic Food Hygiene Certificate and regular on going training) and records of training must be made available on request.
- Best practise of food hygiene must be adopted by the operator. This covers:
 - Personal hygiene
 - Hand washing
 - Ill health
 - Prevention of contamination
 - Temperature control
 - Temperature monitoring
 - Cleaning
 - Storage and stock rotation
 - Procedures in the event of freezer breakdown
 - Site cleanliness
 - Waste disposal
 - Pest control
 - Quality control
 - First aid facilities

Food traders must have a minimum food hygiene rating score of 3.

APPENDIX 'B'

APPLICATION AND SUPPORTING DOCUMENTS

Dear Committee members,

In the last few months, I have been working with Business Sheffield team on a business plan for opening a Gluten-free vegan burgers and sausages tricycle in Sheffield City Centre. My goal is to provide a high quality vegan healthy food at an affordable price, made from the best quality ingredients.

Vegan food is a massive worldwide trend, and although there are two great restaurants that provides vegan friendly food (Humpit, Blue Moon Cafe) in the city centre, there is still a high demand by customers to have fast and affordable options, especially when it comes to Gluten-free food.

I have 15 years of experience of working with some of the best restaurants in Manhattan, Sydney and Tel Aviv, and have 9 years of customer service experience, including working with Samsung previously at Curry's PC world, and recently at John Lewis' Sheffield branch.

My goals are:

- Providing British-based premium vegan burgers and sausages, at an affordable price.
- Gaining level 5 food hygiene rating, with the help and support of NCASS (National Catering Association). Vegan food considered to be very low risk food, and I will work only with suppliers and manufacturers that have level 5 food hygiene rating. I recently received NCASS food hygiene level 3 certificate, to make sure that I'll be able to provide the best quality food.
- Giving an exceptional great service to all of the customers. Due to my customer service skills, I received an award as Samsung's best service provider in the country for 2015. customer service is a real passion to me. I would like to create fun and friendly experience to the wonderful people of Sheffield.
- To provide the safest work environment, a national Living Wage (will be calculate by London's rate, currently £9.15 per hour), provide free NCASS Level 2 training to all assistants, and be a part of the fair trade movement.

After weeks of research, I found out that the best design for both practicality and to give a sense of fun, is the use of an Eco-friendly tricycle.

The tricycle will have a traditional design that can be changed and modified by the management team requests and suggestions, and will provide a safe working environment, according to the health and safety regulations.

The tricycle made with the highest industry standards, using the best 304 food grade stainless steel with high quality aluminium plate surround. A sink with a 12V pump and two 5 litres containers for fresh water and waste.

The top quality LPG griddle is recommended by the National Catering Association, and is certified to the highest standards, gas bottle will be placed inside the end box.

The roof holds an eco-friendly solar panel, which will provide green energy to the LED light strip.

The tricycle will come with a full body wind and rain protection, made of the best materials, to provide a safe working environment.

Both Business Sheffield and myself like to ask for your support in this application.

Thank you for your time and help,

Kind regards,

Adi Sela

Local Government (Miscellaneous Provisions) Act 1982

Rec - 72385
E100 - coal

Application for a (City Centre – small unit) Street Trading Consent

Notes to Applicant:

All questions must be answered unless otherwise stated.
If relevant questions are not answered, the application will be deemed incomplete and returned to the Applicant.

*I / *WE HEREBY APPLY to the Sheffield City Council for the grant of a (city centre – small unit) street trading consent.

A. THE APPLICANT(S)

LICENSING
1 AUG 2017
SERVICES

		1 st Applicant (Mr/Mrs/Miss/other)	2 nd Applicant (Mr/Mrs/Miss/other)
Q1	Full name(s) of the applicant		
Q2	Applicant(s) permanent private address		
Q3	Date of birth		
Q4	Nationality and place of birth		
Q5	National Insurance No.		
Q6	Do you have the legal right to work and live in the UK?	YES / NO Details:	YES / NO Details:
Q7	Have you ever been refused a street trading consent in this or any other area?	YES / NO Details:	YES / NO Details:
Q8	Telephone No		
Q9	Email address		

B. COMPANY DETAILS (if applying as a Corporate body)

Q10	Name	No Meat Today Limited
Q11	Registered address	[REDACTED] [REDACTED] [REDACTED]
Q12	Registered number	10874298
Q13	Telephone number	[REDACTED]
Q14	Email address	[REDACTED]
Q15	Please provide details of all Directors (names, addresses, dates of birth and details of any convictions). A separate sheet may be used.	Adi Sela, [REDACTED] [REDACTED] [REDACTED] No convictions.

C. TRADING DETAILS

Q16	Trading Name (if applicable)	No Meat Today
Q17	Trading address (if different from above) Post Code	
Q18	Site to be occupied	Fargate, see plan for preferred site. Happy to be sited anywhere.
Q19	Items to be sold (i.e. type of food, jewellery, paintings, etc)	Vegan burgers, vegan sausages, snacks
Q20	Please specify preferred days of trade:	7 days
Q21	Please specify preferred hours of trade:	07:00 – 19:00

D. THE UNIT

Q19	Type: eg barrow / cart, etc.	Tricycle
Q20	Size of unit	Height: 2500mm Width: 1100mm when close, 2000mm when open Length: 2400mm

E. CONVICTIONS / CAUTIONS

Q21	Have any of the applicants ever been convicted of a criminal offence, whether in the United Kingdom or elsewhere? If the answer is Yes please give full details below:	Applicant 1 Yes [] No [No]	
		Applicant 2 Yes [] No []	
Details of previous convictions and/or cautions			
	Date of Conviction	Court of Conviction	Nature of Offence
	Applicant 1		
	Applicant 2		

F. CHECK LIST

The following documents must be attached with this application:

(tick)

Non refundable fee of £100	
Your current passport	/
Your current drivers licence	/
One other proof of identity, showing your name and current address (recent utility bill, bank statement etc)	/
Right to work documentation (if applicable)	N/A
Two (recent and identical) passport size photographs signed and dated on the reverse as a true likeness.	✓
Photographs of the vehicle / unit, front back and rear.	✓
Details of any food hygiene qualifications (unless trading in non food items)	✓
If trading in food, confirmation that the business has a food hygiene score rating of 3 or more.	-
Confirmation your vehicle meets the quality criteria	-
Any further information you may wish to submit in support of your application	✓

The following documents must be forwarded to us before the grant of your consent:

(tick if enclosed with this application)

The remaining quarterly fee or full annual fee.	
Certificate of insurance in respect of the vehicle / unit	
Public liability insurance (minimum of £2,000,000)	
Written confirmation that the vehicle meets the Council's food safety standards	
Waste management contract	
Declare that you have registered as a food business	

G. DECLARATION

WARNING

Paragraph 10(3) of Schedule 4 to the Local Government (Miscellaneous Provisions) Act 1982 gives the following warning:-

“Any person who, in connection with an applicationfor a street trading consent, makes a false statement which he knows to be false, in any material respect, or which he does not believe to be true, shall be guilty of an offence.”

I / We,

- declare that all the information I have given in this application is complete and correct;
- declare that I am over 17 years of age (in cases of individual applicants)
- declare I understand and will comply with the Sheffield City Council Street Trading Consent Conditions;
- undertake to pay Sheffield City Council the relevant consent fee in advance whether demanded or not;
- understand that consents are not transferable;
- understand that the Local Authority reserve the right to make further enquiries with South Yorkshire Police as a result of this application as they may consider desirable; and
- understand that giving false information is an offence and may result in prosecution and / or a street trading consent being refused or revoked:

	<p>Applicant 1</p> <p>Signature: </p> <p>Print name: ADI SELA</p> <p>Date: 14.8.17</p> <p>Capacity: Director</p>
	<p>Applicant 2</p> <p>Signature:</p> <p>Print name:</p> <p>Date:</p> <p>Capacity:</p>

Please read these notes before completing the application form.

- If there is insufficient room on this form to fully answer the questions; or if you wish to make any further statement in support of your application, please do so on a separate sheet of paper attached to this form.
- None of the information which you supply on (or with) this form will be treated as confidential except where it relates to convictions.
- The Council is under no obligation whatsoever to grant a consent to any person; you will be notified of the result of this application, as soon as possible.

Please return the fully completed form and all attachments to:

**Licensing Service,
Block C, Staniforth Road Depot
Staniforth Road
Sheffield
S9 3HD**

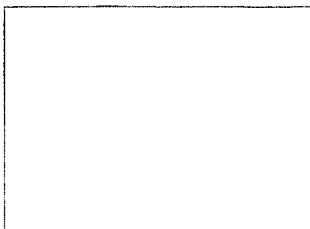
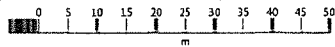
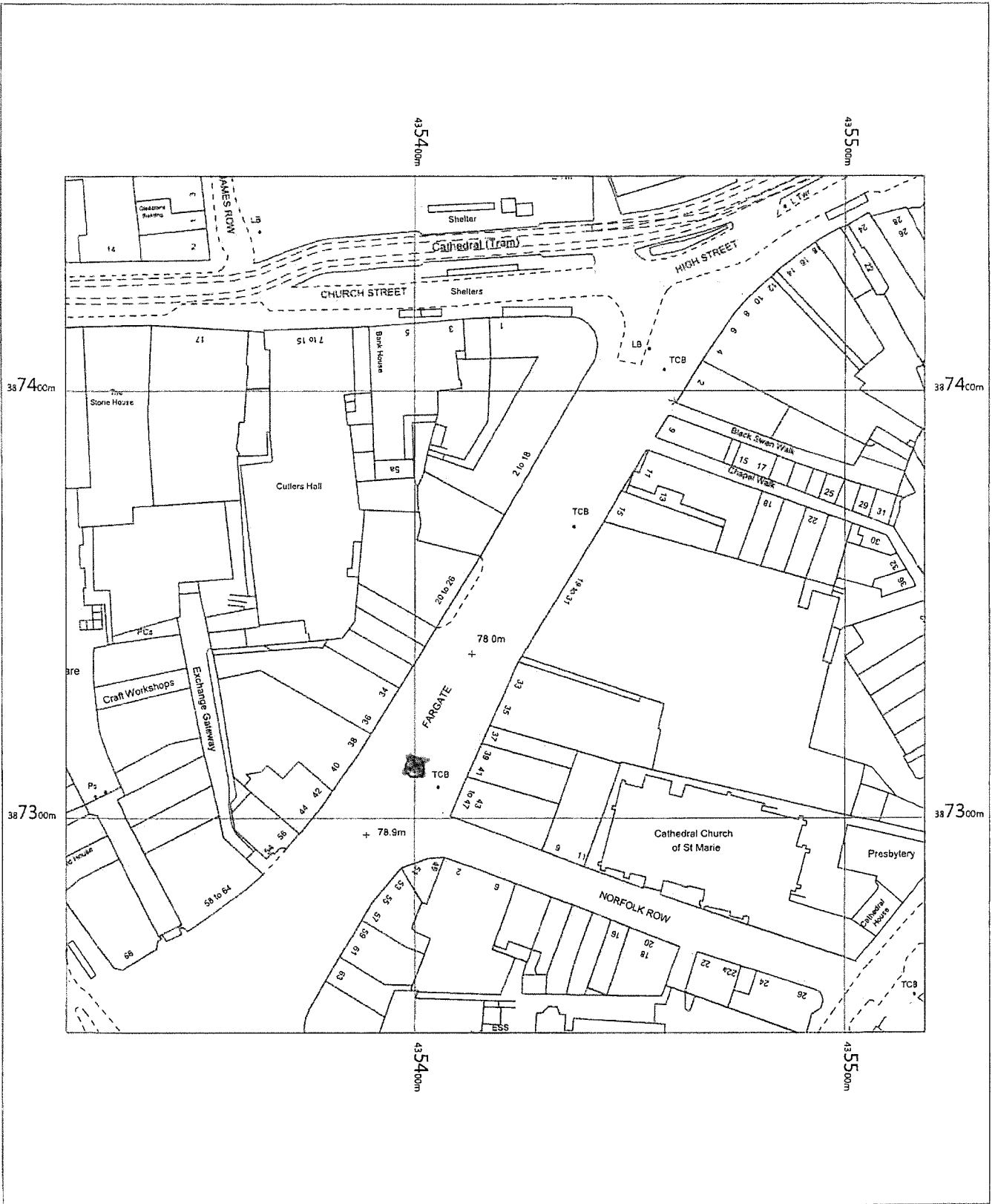

OS MasterMap 1250/2500/10000 scale
 Thursday, August 3, 2017, ID: BW1-00645058
www.blackwellmapping.co.uk

1:1250 scale print at A4, Centre: 435419 E, 387350 N

©Crown Copyright Ordnance Survey Licence No. 100071041



BLACKWELL'S
www.blackwellmapping.co.uk

TEL: 0114 268 7658
maps.sheffield@blackwell.co.uk

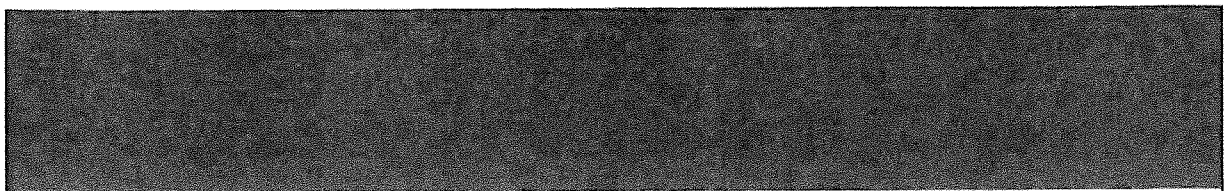

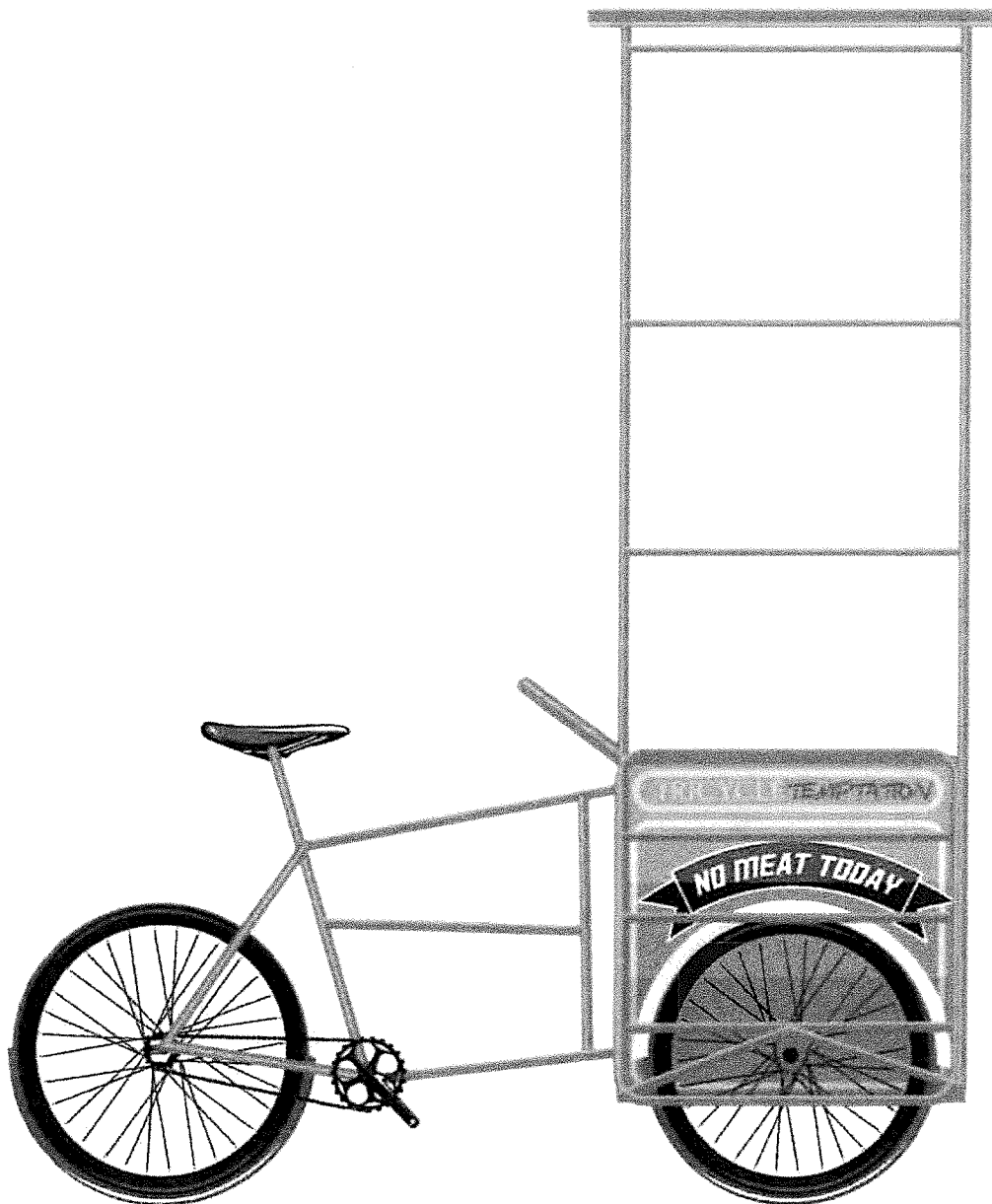

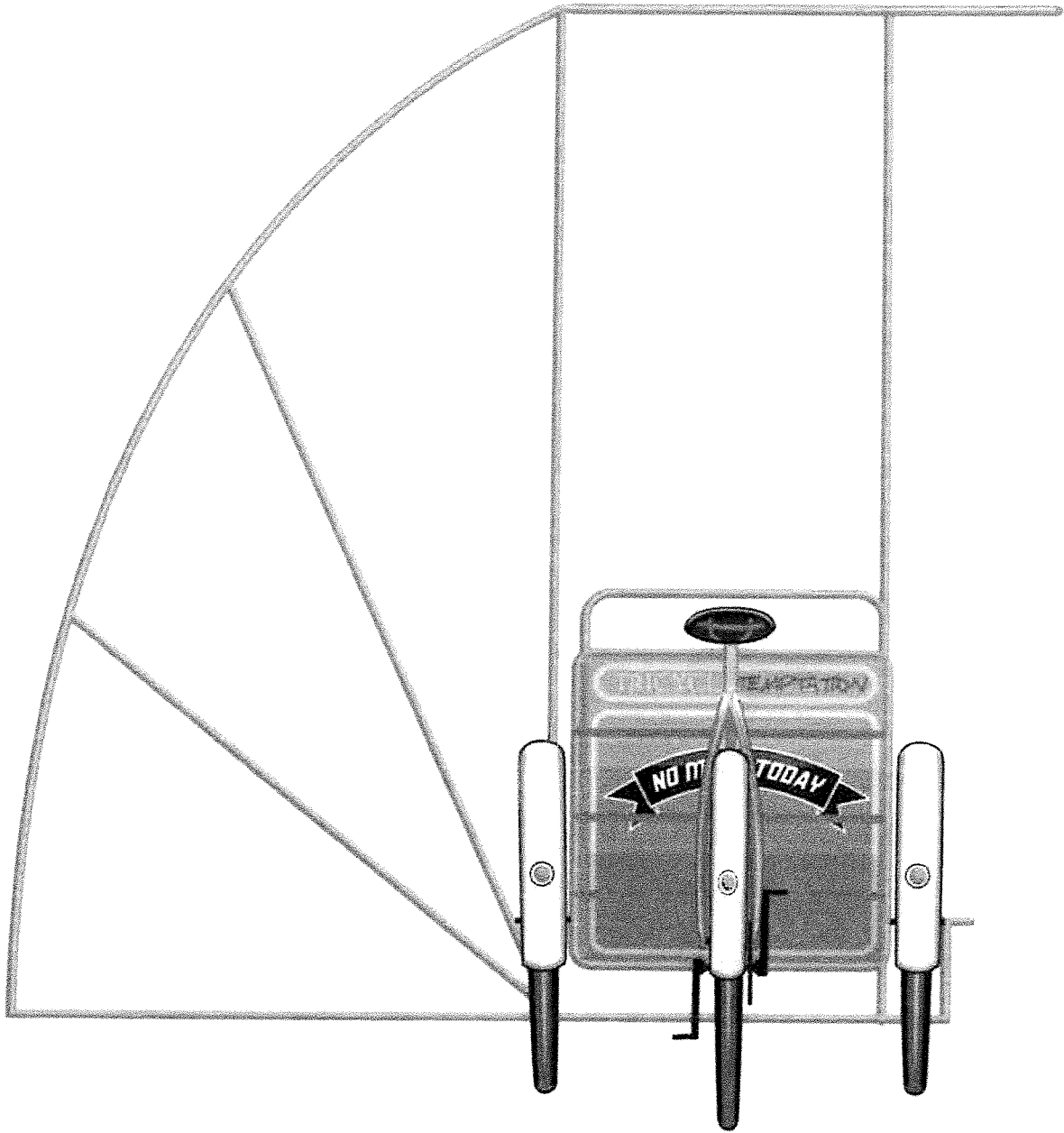

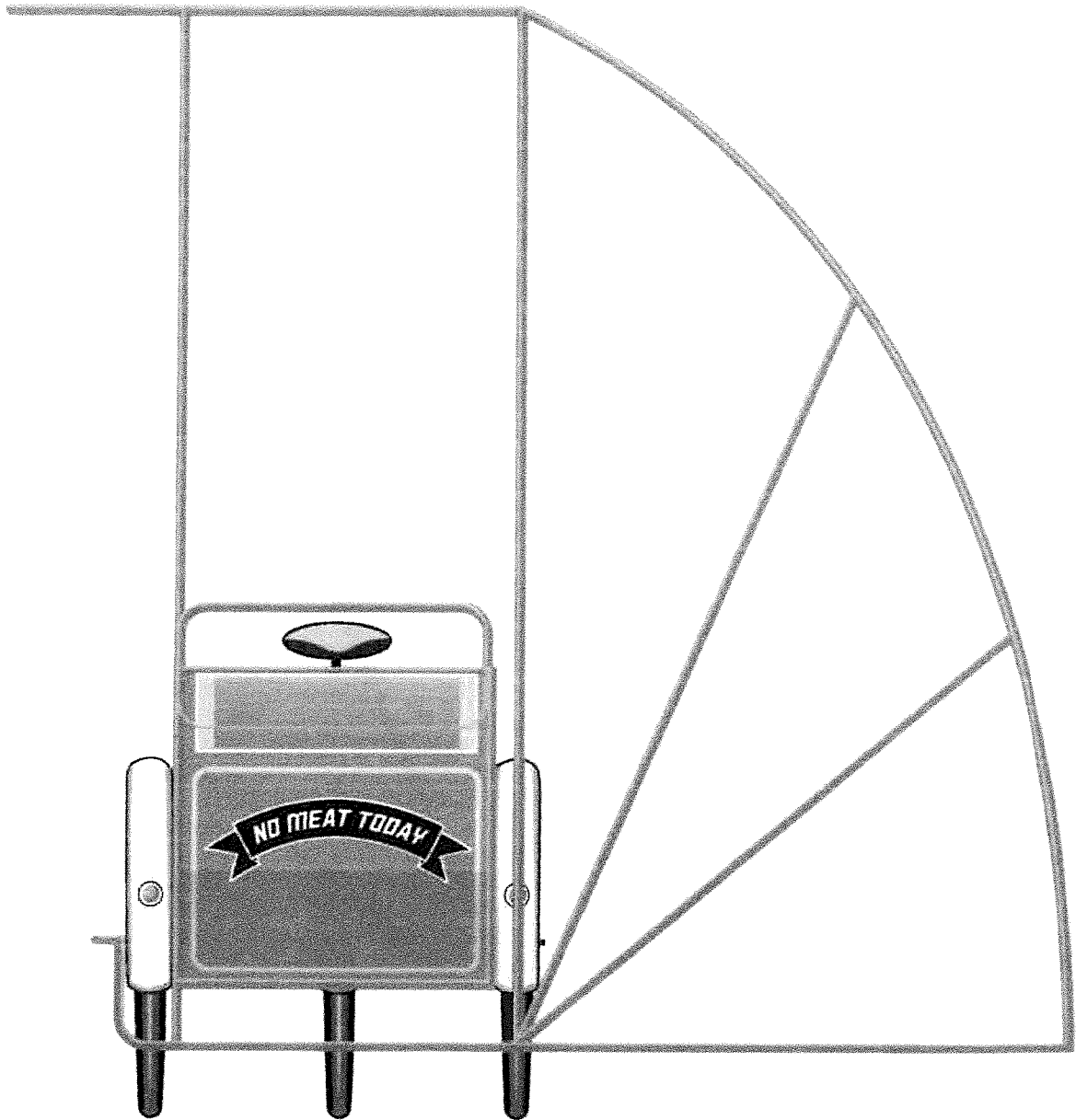

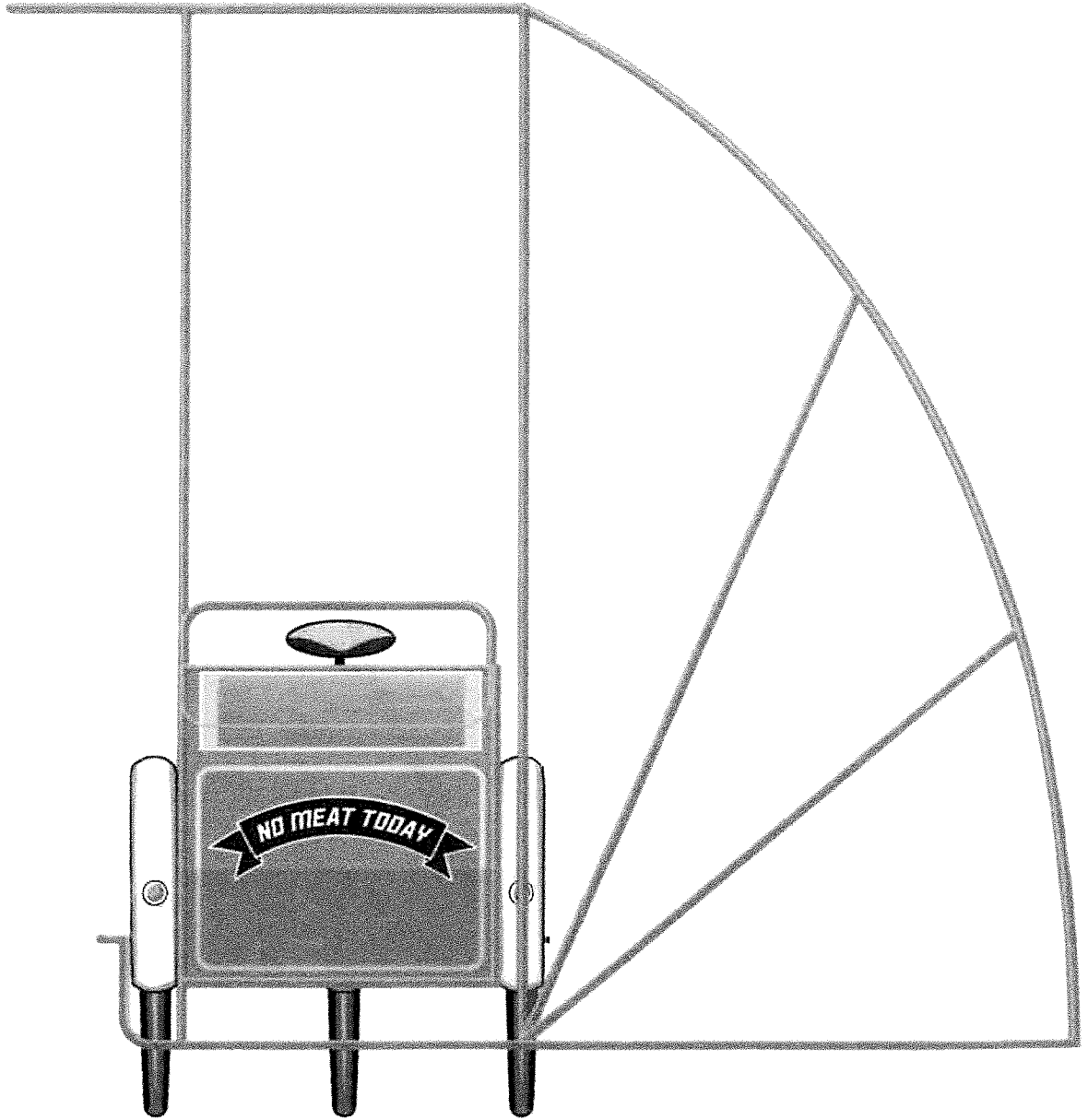

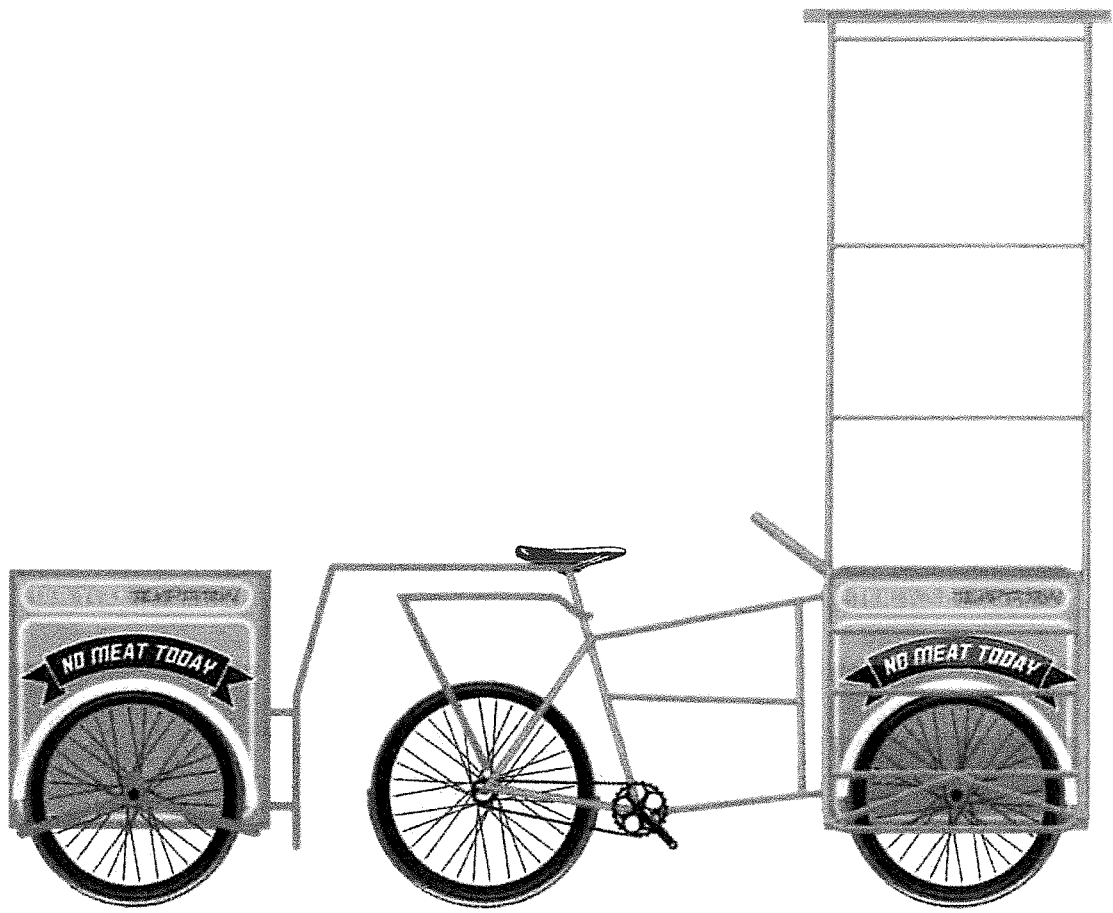

EXAMPLE OF Wind Protection
ON BIKE

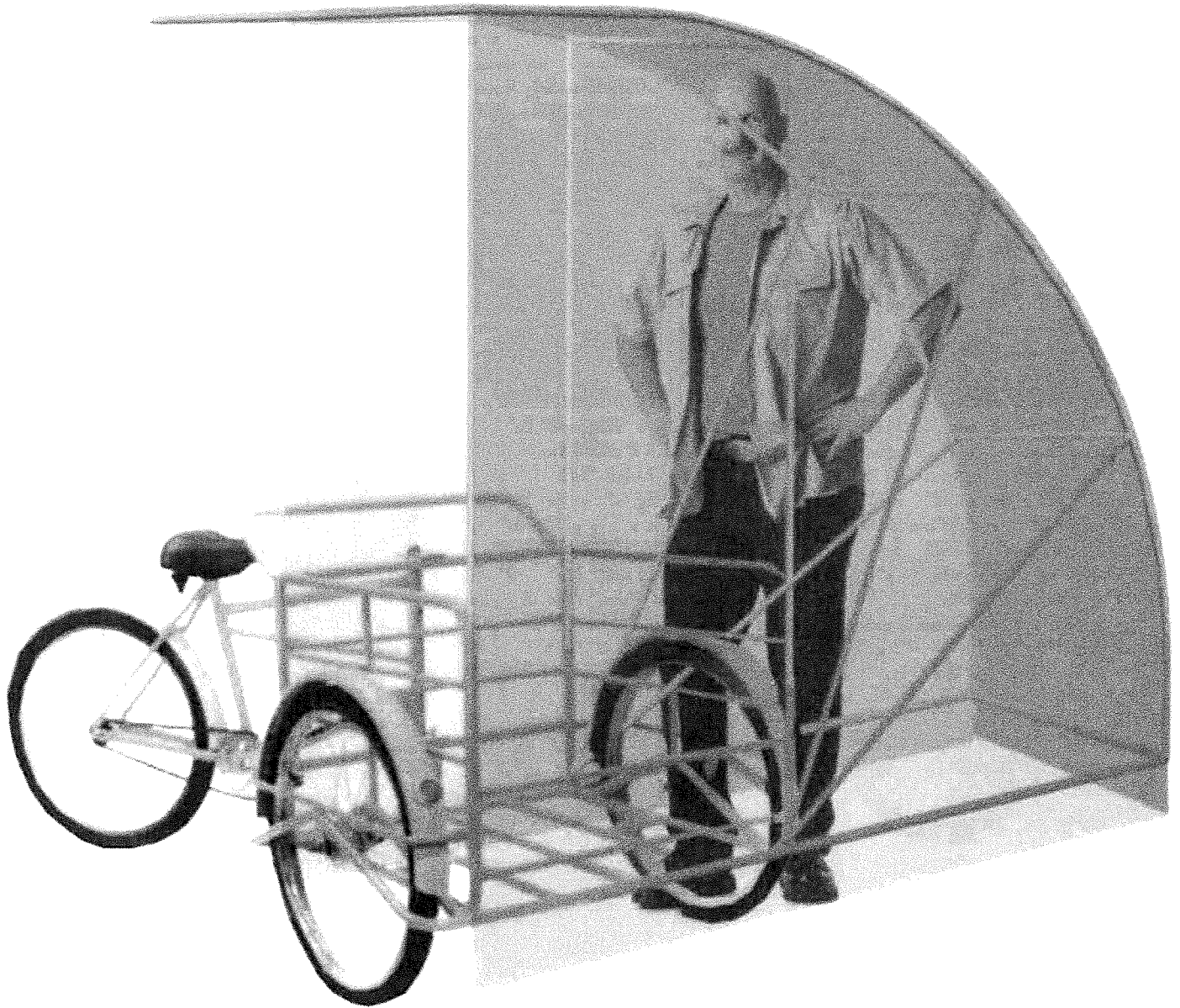

EXAMPLE OF INTERNAL SETTINGS

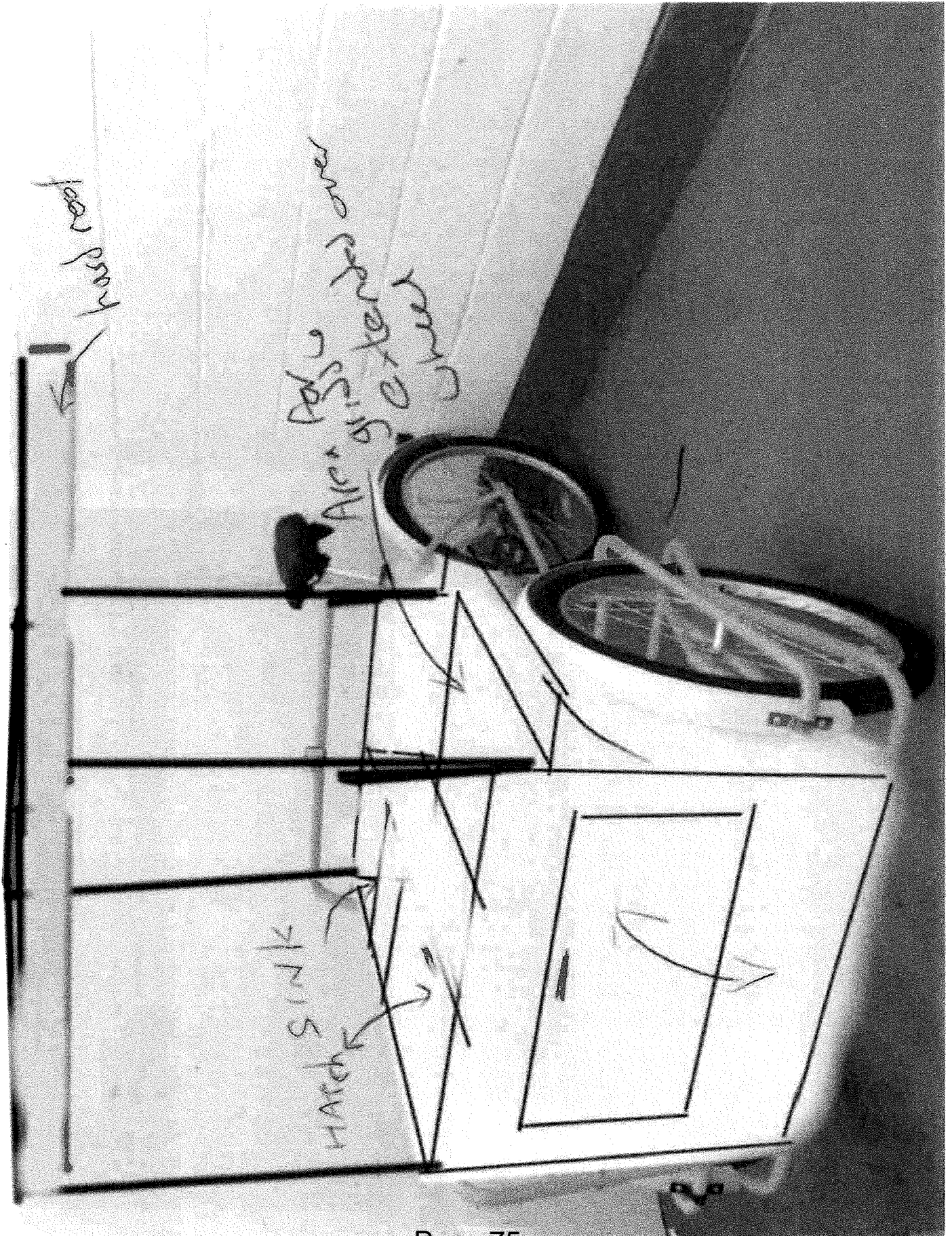

EXAMPLE OF TRICE.



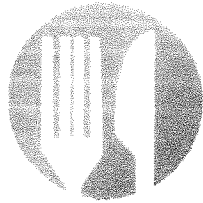

NCASS
NATIONWIDE
CATERERS
ASSOCIATION

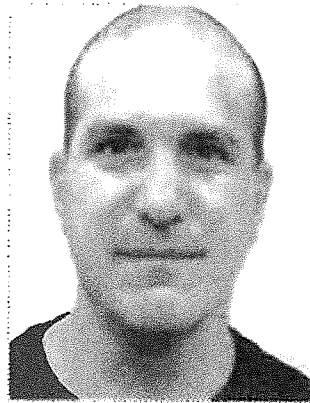

City & Guilds | **Accredited**
Programme

NCASS FOOD HYGIENE LEVEL 3

Awarded to:
Adi Sela

This is to certify that the above named has completed an online course in the following subjects:

Supervisory Management, Food Safety, Microbiology, Hazards, Pest Control, Temperature Control, Cleaning, Contamination Control, Applying & Monitoring Good Food Safety Measures, Quality Control, Contributing to the Food Safety Training of Others, Legislation.

Date Taken: 21/Jul/2017

Valid Until: 21/Jul/2020

R Fox (Director)
 On behalf of the Association

Cherwell
 DISTRICT COUNCIL
 NORTH OXFORDSHIRE

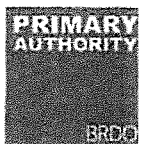

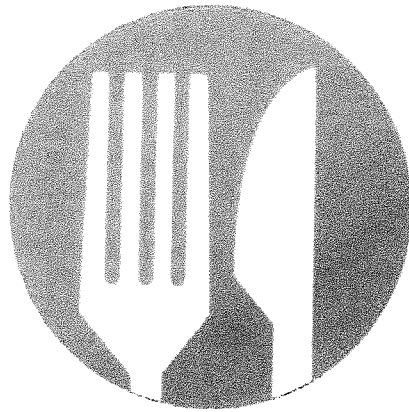

NCASS
NATIONWIDE
CATERERS
ASSOCIATION

This is to Certify that

No Meat Today

Is a member of

**The Nationwide Caterers
Association**

Membership No: 18528

Valid Until: 18/Jul/2018

Tel: 0121 603 2524, ~~and~~ Web: www.ncass.org.uk

Rhodes Emma (CEX)

From: Adi Sela [REDACTED]
Sent: 12 September 2017 11:55
To: Rhodes Emma (CEX)
Subject: Fwd: Vegan food tricycle application

Begin forwarded message:

From: "Murphy Robert (GN CLLR)" <Robert.Murphy@sheffield.gov.uk>
Date: 12 September 2017 at 11:40:23 BST
To: 'Adi Sela' [REDACTED]
Subject: RE: Vegan food tricycle application

Hi Adi,

Sorry for the long delay in replying. I have no objections, good luck.

Kind regards, Rob

From: Adi Sela [REDACTED]
Sent: 11 August 2017 13:14
To: Murphy Robert (GN CLLR)
Subject: Vegan food tricycle application

Dear councilor Robert Murphy,

I would like to ask for your support with this application

In the last few months, I have been working with Business Sheffield team on a business plan for opening a Gluten-free vegan burgers and sausages tricycle in Sheffield City Centre. My goal is to provide a high quality vegan healthy food at an affordable price, made from the best quality ingredients.

Vegan food is a massive worldwide trend, and although there are two great restaurants that provides vegan friendly food (Humpit, Blue Moon Cafe) in the city centre, there is still a high demand by customers to have fast and affordable options, especially when it comes to Gluten-free food.

I have 15 years of experience of working with some of the best restaurants in Manhattan, Sydney and Tel Aviv, and have 9 years of customer service experience, including working with Samsung previously at Curry's PC world, and recently at John Lewis' Sheffield branch.

My goals are:

- Providing British-based premium vegan burgers and sausages, at an affordable price.

- Gaining level 5 food hygiene rating, with the help and support of NCASS (National Catering Association). Vegan food considered to be very low risk food, and I will work only with suppliers and manufacturers that have level 5 food hygiene rating. I recently received NCASS food hygiene level 3 certificate, to make sure that I'll be able to provide the best quality food.
- Giving an exceptional great service to all of the customers. Due to my customer service skills, I received an award as Samsung's best service provider in the country for 2015. customer service is a real passion to me. I would like to create fun and friendly experience to the wonderful people of Sheffield.
- To provide the safest work environment, a national Living Wage (will be calculate by London's rate, currently £9.15 per hour), provide free NCASS Level 2 training to all assistants, and be a part of the fair trade movement.

After weeks of research, I found out that the best design for both practicality and to give a sense of fun, is the use of an Eco-friendly tricycle. The tricycle will have a traditional design that can be changed and modified by the management team requests and suggestions, and will provide a safe working environment, according to the health and safety regulations.

The tricycle made with the highest industry standards, using the best 304 food grade stainless steel with high quality aluminium plate surround. A sink with a 12V pump and two 5 litres containers for fresh water and waste. The top quality LPG griddle is recommended by the National Catering Association, and is certified to the highest standards, gas bottle will be placed inside the end box.

The roof holds an eco-friendly solar panel, which will provide green energy to the LED light strip.

The tricycle will come with a full body wind and rain protection, made of the best materials, to provide a safe working environment.

Photo example attached.

Both Business Sheffield and myself would like to ask for your support with this application.

Thank you for your time and help,

Kind regards,

Adi Sela

Johnson Douglas (GN CLLR)
RE: Vegan food tricycle application
12 Aug 2017, 15:34:28
Adi Sela [REDACTED]

Thanks Adi - no, it sounds like a positive thing to me so good luck with it.

Regards,
Douglas

Cllr Douglas Johnson,
City Ward, Sheffield (Green Party)
[07500 766 189](tel:07500766189)

From: Adi Sela [REDACTED]
Sent: 11 August 2017 19:26
To: Johnson Douglas (GN CLLR)
Subject: Re: Vegan food tricycle application

Dear Douglas Johnson,

Thank you for your quick reply, I appreciate that.
At this point the biggest support that I can hope for, is simply to have no objections from the respectable councilors, if and when the licensing committee will ask for comments.

Also, I will love to discuss charity events in the future.

Thank you again,
Kind regards,
Adi

On 11 Aug 2017, at 19:17, Johnson Douglas (GN CLLR) <Douglas.Johnson@sheffield.gov.uk> wrote

Hi Adi,

This sounds very positive and you have obviously put a lot of thought into this enterprise. What sort of support did you have in mind though?

Regards,
Douglas

Cllr Douglas Johnson,
City Ward, Sheffield (Green Party)
[07500 766 189](tel:07500766189)

From: Adi Sela [REDACTED]
Sent: 11 August 2017 13:11
To: Johnson Douglas (GN CLLR)

Subject: Vegan food tricycle application

Dear councilor Douglas Johnson,

I would like to ask for your support with this application

In the last few months, I have been working with Business Sheffield team on a business plan for opening a Gluten-free vegan burgers and sausages tricycle in Sheffield City Centre. My goal is to provide a high quality vegan healthy food at an affordable price, made from the best quality ingredients.

Vegan food is a massive worldwide trend, and although there are two great restaurants that provides vegan friendly food (Humpit, Blue Moon Cafe) in the city centre, there is still a high demand by customers to have fast and affordable options, especially when it comes to Gluten-free food.

I have 15 years of experience of working with some of the best restaurants in Manhattan, Sydney and Tel Aviv, and have 9 years of customer service experience, including working with Samsung previously at Curry's PC world, and recently at John Lewis' Sheffield branch.

My goals are:

- Providing British-based premium vegan burgers and sausages, at an affordable price.
- Gaining level 5 food hygiene rating, with the help and support of NCASS (National Catering Association). Vegan food considered to be very low risk food, and I will work only with suppliers and manufacturers that have level 5 food hygiene rating. I recently received NCASS food hygiene level 3 certificate, to make sure that I'll be able to provide the best quality food.
- Giving an exceptional great service to all of the customers. Due to my customer service skills, I received an award as Samsung's best service provider in the country for 2015. customer service is a real passion to me. I would like to create fun and friendly experience to the wonderful people of Sheffield.

- To provide the safest work environment, a national Living Wage (will be calculate by London's rate, currently £9.15 per hour), provide free NCASS Level 2 training to all assistants, and be a part of the fair trade movement.

After weeks of research, I found out that the best design for both practicality and to give a sense of fun, is the use of an Eco-friendly tricycle. The tricycle will have a traditional design that can be changed and modified by the management team requests and suggestions, and will provide a safe working environment, according to the health and safety regulations.

The tricycle made with the highest industry standards, using the best 304 food grade stainless steel with high quality aluminium plate surround. A sink with a 12V pump and two 5 litres containers for fresh water and waste. The top quality LPG griddle is recommended by the National Catering Association, and is certified to the highest standards, gas bottle will be placed inside the end box.

The roof holds an eco-friendly solar panel, which will provide green energy to the LED light strip.

The tricycle will come with a full body wind and rain protection, made of the best materials, to provide a safe working environment.

Photo example attached.

Both Business Sheffield and myself would like to ask for your support with this application.

Thank you for your time and help,

Kind regards,

Cooper Steve (DEL)
RE: Veggie burgers pitch advice
11 Jul 2017, 13:39:51
Adi Sela [REDACTED]

Hello Adi,

Thanks for your email.

I have had a look at the pictures of the bike you are considering trading from and the proposed product and think it would make a great addition to the City Centre street food scene. If you decide to proceed with an application for one of the sites we would have no objections based on the information provided below.

Regards
Steve

Steve Cooper
City Centre Resources Manager
Business Management Team
Sheffield City Council
City Centre Management Unit
177 The Arcade
S1 2EG
0114 2736832/0797 0736732

From: Adi Sela [REDACTED]
Sent: 11 July 2017 11:43
To: Cooper Steve (DEL)
Subject: Veggie burgers pitch advice

Dear Sir/Madam,

I would like to ask for your expert advice about opening a stand in the city centre.

In the last few weeks, I have been working with the Business Sheffield team on a business plan for opening a Veggie burgers and sausages pitch in Sheffield City Center. My goal is to provide a high quality vegetarian and vegan healthy food at an affordable price, made from the best quality ingredients

I have 15 years of experience of working with some of the best restaurants in Manhattan, Sydney and Tel Aviv, and have 9 years of customer service experience, including working with Samsung previously at Curry's PC world, and recently at John Lewis' Sheffield branch.

Providing British premium vegetarian/vegan sausages, at an affordable price.

Gaining level 5 food hygiene rating.

Giving an exceptional great service to all of the customers.

Creating fun and friendly experience to the wonderful people of Sheffield.

To provide the safest work environment.

After weeks of research, I found out that the best design for both practicality and to give a sense of fun, is to use an Eco-friendly tricycle cart. The tricycle will have a traditional design that can be changed and modified by the management team requests and suggestions, and will provide a safe working environment, according to the health and safety regulations. All the products will be provided by high quality British based companies. Waste packaging will be taken to a recycle center.

Both Business Sheffield and myself like to ask for your support in this application, and will be thankful for your input.

Thank you for your time and help,

Best regards,

Adi Sela

planningdc.cityeast@sheffield.gov.uk
RE: Vegan food tricycle application
11 Aug 2017, 16:38:18

[REDACTED]
licensing@cityeast.sheffield.gov.uk

Dear Adi,

Thanks you for your e-mail.

Whilst there are no in principle objections to your proposal from a planning perspective I can advise that the Council's Licensing Service deal with all applications for street trading in the city centre.

I have replied my response to them so that they can explain the application process to you.

Regards,

Lucy Bond
Acting Business Manager & Area Team Manager
(City Centre & East Area)
Development Management
Planning Service
City Growth
Sheffield City Council

We offer an integrated planning and building control service

Website: www.sheffield.gov.uk/cityeast or www.sheffield.gov.uk/buildingcontrol

Location: 4th Floor Howden House, 1 Union Street, Sheffield S1 2SH

Apply for planning permission online at: www.sheffield.gov.uk/planning

Apply for building regulation permission online to: www.sheffield.gov.uk/buildingcontrol



- Stack Sites into the Excellence in Planning to Deliver Housing category
- City to Green into the Excellence in Planning to Create Economically Successful Places category

From: licensing@cityeast.sheffield.gov.uk
Sent: 11 August 2017 13:32
To: planningdc.cityeast@sheffield.gov.uk
Subject: FW: Vegan food tricycle application

From: Adi Sel [REDACTED]
Sent: 11 August 2017 13:21
To: planningdc.cityeast@sheffield.gov.uk
Subject: Vegan food tricycle application

Dear Sir/Madam,

I would like to ask for your support with this application.

In the last few months, I have been working with Business Sheffield team on a business plan for opening a Gluten-free vegan burgers and sausages tricycle in Sheffield City Centre. My goal is to provide a high quality vegan healthy food at an affordable price, made from the best quality ingredients.

Vegan food is a massive worldwide trend, and although there are two great restaurants that provides vegan friendly food (Humpit, Blue Moon Cafe) in the city centre, there is still a high demand by customers to have fast and affordable options, especially when it comes to Gluten-free food.

I have 15 years of experience of working with some of the best restaurants in Manhattan, Sydney and Tel Aviv, and have 9 years of customer service experience, including working with Samsung previously at Curry's PC world, and recently at John Lewis' Sheffield branch.

My goals are:

APPENDIX 'C'

APPLICANT MEETING INVITE

SHEFFIELD CITY COUNCIL

LOCAL GOVERNMENT MISCELLANEOUS PROVISIONS ACT 1982

Street Trading – City Centre Street Trading Consent – Fargate

IMPORTANT: NOTIFICATION OF A COMMITTEE MEETING

To: Mr Adi Sela c/o No Meat Today Ltd



Email: eddie.sela@me.com

LEGISLATION: Local Government (Miscellaneous Provisions) Act 1982

LICENCE TYPE: City Centre Street Trading Consent – Fargate

I refer to the above and the application for the grant of a city centre street trading consent.

This matter has been referred to the Licensing Committee of Sheffield City Council for determination. Full details will be provided in the report to the Committee which will be sent to you in due course. The Licensing Committee has the authority to decide what action to take in relation to each application.

The Committee has indicated that it expects applicants, interested parties and any objectors to attend the meeting.

The meeting in respect of the application will take place on **Tuesday 3rd October 2017** in a Committee Room of the Town Hall, Sheffield, S1 2HH (Pinstone Street entrance) and you are invited to attend at **11:30 am**.

PLEASE NOTE:

I would be grateful if you could confirm that you will be attending the meeting by telephoning the Licensing Office on 0114 2734264.

Handwritten signature of Steve Lonnia in black ink.

.....
Steve Lonnia
Chief Licensing Officer
Head of Licensing

Date: 20th September 2017

IMPORTANT: A DECISION IS LIKELY TO BE MADE ON THIS ISSUE WHETHER YOU MAKE REPRESENTATION OR NOT.

Licensing Service, Business Strategy and Regulation, Block C Staniforth Road Depot,
Staniforth Road, Sheffield, S9 3HD Telephone 0114 2734264

**The Licensing Service Reception is open from 10.00am to 4.00pm, Monday to Friday.
Telephone calls can be taken from 09:00am to 5:00pm.**

APPENDIX 'D'

HEARING PROCEDURE

**STREET TRADING CONSENT APPLICATION
SUB-COMMITTEE HEARING PROCEDURE**

This procedure has been drawn up to assist those parties attending Street Trading Consent Committee hearings.

1. The Chair of the Licensing Committee will introduce the Committee and ask officers to introduce themselves.
2. The Chair will ask the applicants and interested parties to formally introduce themselves.
3. The Solicitor to the Committee will outline the procedure to be followed at the hearing.
4. Hearing Procedure:-
 - (a) The Licensing Officer will introduce the report.
 - (b) Questions concerning the report can be asked both by Members and the applicant.
 - (c) The applicant/consent holder (or his/her nominated representative) will then be asked to:-
 - (i) detail the application;
 - (ii) provide clarification on the application and respond to the representations made.
 - (d) The Chair of the Licensing Committee will invite Members of the Sub-Committee and all other parties present to put any relevant questions to the applicant and/or his/her representative.
 - (e) Consultees / interested parties will be invited to present their representations or elect a spokesperson (which may be a Councillor) to speak on their behalf. New representations must not be raised.
 - (f) The Chair of the Licensing Committee will invite Members of the Sub-Committee and all other parties present to put any relevant questions to the consultees / interested parties.
 - (g) The consultees / interested parties will be invited to sum up. A maximum of 5 minutes will be allowed.
 - (h) The applicant will be invited to sum up. A maximum of 5 minutes will be allowed.
 - (i) The Licensing Officer will then detail the options.
 - (j) There will then be a private session for Members to take legal advice and consider the application.
 - (k) Once a decision has been reached, all parties will be invited to return. The Sub-Committee's decision and reasons will be announced by the Chair.
 - (l) The Sub-Committee's decision will be confirmed in writing to the applicant and those parties who made representations.

- NB:
- 1) At any time in the Licensing Process Members of the Committee may request legal advice from the Solicitor to the Committee. This advice may be given in open session or in private.
 - 2) The Committee Hearing will be held in public unless and in accordance with the Regulations the Committee determine that the public should be excluded.

There is no right of appeal against the Council's decision to refuse to grant or revoke a Street Trading Consent



SHEFFIELD CITY COUNCIL

LOCAL GOVERNMENT (MISCELLANEOUS PROVISIONS) ACT 1982

STREET TRADING POLICY

**Licensing Service
Place Portfolio
Business Strategy and Regulation
Block C, Staniforth Road Depot
Staniforth Road
Sheffield
S9 3HD**

**Telephone Number: 0114 2734264
Fax Number: 0114 273 4073**

**Or visit our website: www.sheffield.gov.uk/licensing
Or email us at: licensing@sheffield.gov.uk**

Reception Opening Times

Monday to Friday

10:00 to 16:00

SHEFFIELD CITY COUNCIL
LOCAL GOVERNMENT
(MISCELLANEOUS PROVISIONS) ACT 1982

STREET TRADING POLICY

Contents

	Page
1.0 PART 1 - INTRODUCTION	4
1.1 Purpose of the Policy	4
1.2 Objective of the Policy	4-6
1.3 Consultation	6
1.4 Review of the Policy	6
1.5 Departure of the Policy	6
1.6 The Legislation	6-7
1.7 Exemptions	7-8
1.8 Street trading for which consent is not required	8
2.0 PART 2 - APPLICATIONS AND DETERMINATION	9
2.1 Types of street trading	9
2.2 Fees	9
2.3 Conditions	9-10
2.4 Qualitative Criteria	10
2.5 Applications	10-11
2.6 Consultation on applications for consents	11-12
2.7 Consideration of applications by the Licensing Committee	12
2.8 Granting, Refusal or Revoking Street Trading Consents	13-15
2.9 Approval of applications	15-16
3.0 PART 3 – STREET TRADING CONSENTS	17
3.1 City Centre Street Trading	17-18
3.2 Static street Trading	18-19
3.3 Mobile Street Trading – Fruit and Vegetable	19-20
3.4 Ice cream Mobile Traders	20
3.5 School Street Trading	21
3.6 Football Street Trading	21-22
3.7 Short term Street Trading Consents	22
3.8 Applicants and Assistants	22-23
3.9 Renewals	23
3.10 Annual Static Consents with quarterly payments	23-24
3.11 Transfers	24
3.12 Variations	24
4.0 PART 4 – CONDITIONS AND ENFORCEMENT	25
4.1 Conditions and enforcement	25

5.0	PART 5 – OTHER LEGISLATION	26
5.1	Planning Permission	26
5.2	Licensing Act 2003	26
5.3	Traffic Regulation Orders	26
5.4	Food Establishments	26
5.6	Trade Waste Disposal	26
6.0	PART 6 – USEFUL INFORMATION AND CONTACT DETAILS	27
6.1	Authorities	27-28
6.2	First point for Business	28
	APPENDIX	
Appendix 1 –	Sheffield Boundary Map	29-30
Appendix 2 –	Standard Conditions	31-34
Appendix 3 –	Additional Ice Cream Mobile Conditions	35
Appendix 4 –	Additional Fruit and vegetable traders mobile conditions	36
Appendix 5 –	Additional Static Conditions	37
Appendix 6 –	City Centre Qualitative Criteria	38-39
Appendix 7 –	City Wide Qualitative Criteria	40-42
Appendix 8 –	Delegation of Functions	43
Appendix 9 –	Guidelines relating to the relevance of convictions	44-46
Appendix 10 –	City Centre Boundary	47
Appendix 11 –	Plan and radius - Sheffield Wednesday Football Club	48-49
Appendix 12 –	Plan and radius - Sheffield United Football Club	50-51
Appendix 13 –	Plan and radius – Don Valley Stadium	52-53
Appendix 14 –	Plan and radius – Sheffield Motorpoint Arena	54-55

1.0 PART 1 - INTRODUCTION

1.1 Purpose of the Policy

- 1.1.1 Street activities are an essential ingredient of a vibrant and lively city and in Sheffield there is a strong demand for legitimate small scale street trading. They offer an opportunity for small businesses to get started with a relatively modest outlay.
- 1.1.2 The street trading scheme is part of Sheffield City Council's campaign to make Sheffield a more attractive and vibrant place and fits in with our Corporate Plan 2011-2014 which sets out Sheffield's strategic directions and priorities. The street trading policy supports the corporate priorities which include; *'Standing up for Sheffield'*, *'Supporting and Protecting Communities'*, *'Focusing on Jobs'* and being *'Business Friendly'*.
- 1.1.3 Sheffield's Street Trading Policy works alongside existing Council strategies (e.g. local crime prevention, planning, tourism, culture strategy and protection of children and vulnerable persons) and the Licensing Authority will ensure continuing co-ordination and integration of these policies.
- 1.1.4 This policy sets out Sheffield City Council's framework for the management of street trading in the city of Sheffield. The scheme also aims to prevent the obstruction of the streets in Sheffield by street traders and ensuring the safety of persons using them. In doing so, it recognises the importance of licensed businesses to the local economy and the character of the area whilst trying to ensure that the activities do not cause nuisance or annoyance to the people in the area.
- 1.1.5 This document will guide the Licensing Authority when it considers applications for Street Trading Consents. It will inform applicants of the parameters in which the Authority will make decisions and how their needs will be addressed.

1.2 The Objectives of this Policy

- 1.2.1 This Policy has been written with a view to securing the following objectives:
- to enhance the city of Sheffield;
 - to protect public health through the control of street trading within the city of Sheffield;
 - to ensure that traders operate within the law and act fairly in their dealings with the public; and
 - to prevent nuisance, unsafe practices and anti social behaviour.
- 1.2.2 Whilst promoting inclusive, vibrant, safe and strong communities and supporting small businesses the Licensing Service will work closely with external partners to support the above objectives.
- 1.2.3 The production of this document and guidance issued with applications will assist us in achieving our service vision of "Doing the right things and doing things right, for our customers and the City, making Sheffield a Great Place to be".

1.2.4 The work we are doing fits with many of our Service objectives of:

- **Effective** – delivering high levels of customer satisfaction.
- **Equitable** – ensuring provision to all without disadvantaging anyone.
- **Empowering** – engaging with customers and involving them in our decisions.
- **Enabling** – working proactively to help make things happen.

1.2.5 It also fits in with our Service design principles of:

- **Collaboration** – working effectively with customers, partners and other stakeholders to provide a streamlined quality service.
- **Responsiveness** – listening and acting in a timely fashion to complaints and queries.
- **Openness** – being transparent and accountable to enforcement issues and decisions made on applications.
- **Flexibility** – by making it easier for customers to make applications, discuss issues, hold meetings and provide information is a convenient and flexible way.
- **Learning** – listening / learning to customers, improving systems and the way we can do things better over time.

1.2.6 The overarching benefits are that the Policy will assist in achieving the Place core strategic outcome of “Making Sheffield a Great Place to Be”.

1.2.7 This will be by supporting the following strategic outcomes:

- **A Strong & Competitive Economy**
 - working with businesses to set up and be a part of the growth of the local economy.
- **A Great Place to Live**
 - **good place management** by involving communities and ensuring traders fit in and contribute to the appearance and enhancing an area ensuring it is safe, attractive and clean by placing conditions and meeting a qualitative criteria.
 - **effective service delivery** by working in collaboration with other agencies, departments and the communities to ensure effective quality service.
- **Vibrant City**
 - by enhancing the **night time economy** by providing customers wants and needs for the city.
 - being **destination of choice** by having variety in the city.
- **Safe & Secure Communities**
 - by working with police, safer neighbourhood officers, etc. to improve communities and tackle problems associated with street trading

- **Successful Young People**
 - **protect and promote the welfare of children** and ensuring the suitability of all applicants.

1.3 Consultation

1.3.1 There is no statutory requirement to consult before determining this licensing policy however to ensure openness and transparency the Council has chosen to consult with the following people and bodies:

- All existing Street Traders
- The Planning Authority (Sheffield City Council)
- The Highways Department (Sheffield City Council)
- City Centre Management Team (Sheffield City Centre)
- South Yorkshire Police
- South Yorkshire Fire and Rescue
- Health Protection Service (Sheffield City Council)
- Environmental Protection Service (Sheffield City Council)
- Community Assemblies
- Local Elected Members
- Shop keepers
- Trade Associations

1.4 Review of the Policy

1.4.1 This policy will be reviewed every three years. At the time of the review, we will again consult all interested parties. As well as the three-yearly reviews, we will continue to evaluate the policy and may update it at any time. Any minor changes can be agreed by the Licensing Committee and/or the Head of Licensing through delegated powers.

1.5 Departure from the Policy

1.5.1 In exercising its discretion in carrying out its regulatory functions, Sheffield City Council will have regard to this Policy document and the principles set out therein.

1.5.2 Notwithstanding the existence of this Policy, each application will be considered on its own merits based on the licensing principles detailed in this Policy.

1.5.3 Where it is necessary for the Council to depart substantially from this Policy, clear and compelling reasons for doing so will be given.

1.6 The Legislation

1.6.1 The Council (Licensing Authority) have power under the provision of the Local Government (Miscellaneous Provisions) Act 1982 (the 1982 Act) to regulate Street Trading in the City.

1.6.2 Street Trading means, the selling or exposing or offering for sale of any article (including a living thing) in a street.

- 1.6.3 Street is defined in the Act as any road, footway, beach or other area to which the public have access and a service area as defined in section 329 of the Highways Act 1980, and also includes any part of a street.
- 1.6.4 The Licensing Committee at its meeting of 29th January 2002 passed the following resolution:
- “1. That under the provisions of schedule 4 of the Local Government (Miscellaneous Provisions) Act 1982:*
- (a) all streets (which includes roads, footways, forecourts or other areas to which the public have access) within the Sheffield City boundary, shall be designated consent streets and;*
- (b) such street trading designation shall take effect as from the 1st April 2002; and*
- (c) all previous designations in relation to street trading will be rescinded as a result of the designation set out above.*
- 2. The effect of this resolution is that from 1st April 2002, it will be an offence to engage in street trading in any street or any other place identified in the above resolution without being authorised to do so by consent from the City Council.”*
- 1.6.5 A Street Trading Consent is therefore required to trade on any street (which includes roads, footways, forecourts, or other City areas to which the public have access without payment) within the Sheffield City boundary.
- 1.6.6 A map of the Sheffield boundary is attached at Appendix 1.
- 1.6.7 In addition, anyone trading on private land, to which the public obtain access without payment, is required to hold a street trading consent.
- 1.6.8 There is no appeal procedure against the refusal or revocation of a consent. An applicant may, however apply for judicial review of the Council’s decision.
- 1.6.9 The Children and Young Persons Act 1933, as amended by the Children and Young Persons Act 1963, controls the employment of children in street trading. The Act prohibits the employment of children under 17 years of age for the purposes of street trading.

1.7 Exemptions

- 1.7.1 For the purpose of Schedule 4 of the Local Government (Miscellaneous Provisions) Act 1982; the following are not street trading:
- trading by a person acting as a pedlar under the authority of a pedlar’s certificate granted under the Pedlar’s Act 1871;

- anything done in a market or fair, the right to hold which was acquired by virtue of a grant, or acquired, or established, by virtue of an enactment or order;
- trading in a trunk road picnic area provided by the Secretary of State under section 112 of the Highways Act 1980;
- trading as a news vendor within the required specification as defined by the 1982 Act trading which:
 - (i) is carried on at premises used as a petrol filling station;
 - (ii) is carried on at premises used as a shop or in a street adjoining premises so used and as part of the business of the shop;
- selling things, or offering or exposing them for sale, as a rounds man;
- the use of trading under Part VIIA of the Highways Act 1980 of an object or structure placed on, in or over a highway;
- the operation of facilities for recreation or refreshment under Part VIIA of the Highways Act 1980; or
- the doing of anything authorised by regulations made under section 5 of the Police, Factories etc. (Miscellaneous Provisions) Act 1916

1.8 Street Trading for which consent is not required

1.8.1 The following Street Trading activities have been deemed by Sheffield City Council as to not require the consent of the Council.

- Charitable, Local Authority organised and community type events (where an admission charge is not made for entry) (i.e. outdoor school fayres, carnivals, fund raisers, car boot sales). Any commercial vendor attending such events will be required to hold a current consent issued by the Council.
- Any market approved by the Council.

2.0 PART 2 – APPLICATIONS AND DETERMINATION

2.1 Types of Street Trading Consents

2.1.1 There are various types of Street Trading Consents in Sheffield which are listed below. The Policy will explain each one in more detail:

- City Centre Street Trading Consent
- Static Street Trading Consent
- Mobile Street Trading Consents for Ice Cream
- Mobile Street Trading Consents for Fruit and vegetable traders
- School Street Trading Consent
- Football Street Trading Consent
- Short term Street Trading Consents
 - 1 month consent
 - 1 week consent
 - 1 day consent

2.2 Fees

2.2.1 Fees will be set and reviewed annually on a full cost recovery basis. The level of fees applicable takes into account the location, the duration of the consent, trading hours, articles to be sold and the enforcement of the terms and conditions of any individual consent. Where trading ceases during the term of a consent, refunds will not be given for any outstanding period of less than 3 months.

2.2.2 For a list of current fees, please contact the Licensing Service on 0114 2037752 or view our web page at www.sheffield.gov.uk/licensing. Fees for static consents are determined at the grant of application.

2.2.3 Applications for annual consents should be accompanied by a non-refundable fee of £100. If the application is approved, the balance of the fee will be due before the consent is issued. If the application is not successful the fee will be retained to cover the cost incurred in processing the application.

2.3 Conditions

2.3.1 When granting or renewing a street trading consent the Authority may attach such conditions as are considered necessary. A standard set of conditions have been produced for all consents and the addition of specific conditions for some of the types of consents may be necessary.

2.3.2 A copy of the conditions are attached:

- Standard conditions - Appendix 2
- Additional mobile ice cream conditions - Appendix 3
- Additional mobile fruit and vegetable traders conditions - Appendix 4
- Additional static conditions - Appendix 5

- 2.3.3 These conditions are subject to an annual review and can be added to or amended for each individual consent granted.
- 2.3.4 Applicants will be required to sign a declaration confirming that they understand and will fully comply with the conditions prior to issuing a consent.
- 2.3.5 The Authority retains the right to vary the conditions of a street trading consent at any time. The conditions may specify the exact location trading may take place from and the times of trading.

2.4 Qualitative Criteria

- 2.4.1 To ensure we promote the objectives of this Policy and make Sheffield a more attractive and vibrant place, applicants must meet the minimum requirements of quality.
- 2.4.2 The Licensing Authority has produced two separate criterion:
- City Centre Qualitative Criteria - Appendix 6
(city centre applications only)
 - City Wide Qualitative Criteria - Appendix 7
(all applications outside the city centre)
- 2.4.3 The criteria sets out the minimum standards required by the Authority and applicants must ensure they meet these standards prior to making an application.
- 2.4.4 All vehicles / units will be inspected prior to the issuing of a consent to ensure they meet the qualitative criteria.

2.5 Applications

- 2.5.1 An application for a Street Trading Consent is not one that can be given tacit approval, as it is in the public interest, safety and policy that the Authority must undertake checks before any application can be granted. We aim to process all applications within 28 days where possible.
- 2.5.2 Applicants must submit the following to the Licensing Authority:
- A completed and signed relevant Street Trading Consent application form.
 - Two (recent and identical) passport size photographs signed and dated on the reverse as a true likeness.
 - The appropriate application fee and/or non refundable fee of £100.
 - Where the proposed street activity is from a fixed position, a copy of an ordnance survey based map of at least 1:1250 scale (a google map will not be sufficient). An additional map to scale clearly identifying the precise trading position and its proximity to other similar retail outlets (shops etc) within an 800 metre radius.

- Proof of identity documentation: passport, driver licence, current utility bill/bank statement and right to work documentation (if applicable).
- 3 colour photographs of any stall, van, barrow, cart etc that will be used for the street trading activity showing the front, rear and side of the unit and dimensions of that unit.
- Written permission from the landowner if the street trading activity is to be carried out on land in private ownership.
- If trading in food, details of any food hygiene qualifications and confirmation that their business has a food hygiene score rating of 3 or above.
- Confirmation that they meet the relevant qualitative criteria.

2.5.3 The following documentation must be forwarded to the Licensing Authority before the grant of a consent:

- An original certificate of insurance that covers the street trading activity for third party and public liability risks up to a minimum of £2,000,000.
- A certificate of insurance in respect of the vehicle and/or the tow vehicle you propose to use.
- An appropriate vehicle test certificate.
- Declare that you have registered as a food business (where appropriate).
- Written confirmation that the vehicle/unit meets the Council's food safety standards.
- Any permissions or consents already granted with regard to the proposed operation, e.g. planning consent, late night refreshment premises licence, waste disposal agreement.

2.5.4 If any of the required documentation expires during the term of the applicants consent, the consent will cease to have effect until the applicant has produced current valid documentation to the Licensing Authority.

2.5.5 Please note: all vehicles / units will be inspected prior to issuing a consent to ensure they meet the qualitative criteria. If the vehicle / unit fails to meet the criteria in the opinion of the Licensing Officer, the matter will be placed before the Licensing Committee for determination.

PLEASE NOTE: Applicants are advised not to purchase the unit until the application has been determined.

2.6 Consultation

2.6.1 Before a consent is granted by the Council for the purposes of street trading we will, where reasonably practicable, seek comments from:

- South Yorkshire Police
 - Highways Department (Sheffield City Council)
 - Planning Department (Sheffield City Council)
 - South Yorkshire Fire and Rescue
 - Where applicable local residents, shop owners and any other person which may be affected
- 2.6.2 Once we receive an application, twenty eight days will be given for comments to be received. If no representations are received the Council may grant the application in the terms applied for, and standard conditions will be attached to the Consent (subject to all other requirements in this policy).
- 2.6.3 Where objections are received and not resolved relating to the grant or renewal of a consent the application will be referred to the Licensing Committee for determination.
- 2.7 Consideration of applications by the Licensing Committee**
- 2.7.1 The Licensing Committee has been established to consider applications and hear objections in relation to licensing matters. The Licensing Committee consists of elected members of Sheffield City Council. These meetings are normally held in public unless there are matters to be considered that are of a confidential nature.
- 2.7.2 A list of the delegation of functions is attached at Appendix 8.
- 2.7.3 On receipt of relevant written objections and/or if the applicant has not met the qualitative criteria, arrangements will be made for the application to be heard by the Licensing Committee and the applicant and all parties making objections, will be notified in writing of the date, time and place where the application will be heard.
- 2.7.4 The person or body making an objection will be expected to attend the hearing and be allowed the opportunity to address the Licensing Committee and ask questions relating to the application. The applicant can be represented by a solicitor, or supported by a friend or colleague.
- 2.7.5 Letters of objection that have been received by the Council will be circulated to members of the Committee in advance. Where appropriate, the letters of objection will also be sent to the applicant but without any information that would identify the person submitting the objection.
- 2.7.6 The Licensing Committee will always determine applications by:
- Considering each case on its merits.
 - Using this Policy to assess applications.
 - Dealing with the hearing in a balanced and impartial manner.
 - Ensuring that the rules of natural justice are applied in any hearings held.
 - Giving all parties sufficient opportunity to present their case, ask questions and present information for consideration in support of their application or objection.

2.8 Grant / Renewal or Revocation of Street Trading Consents

2.8.1 Each application will be considered in accordance with paragraph 2.7.6 above.

2.8.2 In considering applications for the grant or renewal of a Street Trading Consent or revoking a current consent the following factors may be considered:

- **Public Safety / Highway**

- (a) Whether the street trading activity represents or is likely to represent a substantial risk to the public from the point of view of obstruction, fire hazard, unhygienic conditions or danger that may occur when a trader is accessing the site;
- (b) Whether there is sufficient space in the street for the applicant to engage in the trade in which he/she is proposing without causing undue interference or inconvenience to other persons using the street;
- (c) Whether the street trading activity may damage the structure or surface of the street;
- (d) Whether the location and operating times will be such that the highway can be maintained and that there are no dangers to those who have a right to use the highway and no obstruction for emergency services.

- **Public Order**

- (a) Whether the street trading activity represents, or is likely to represent a substantial risk to public order.

- **Avoidance of Public Nuisance**

- (a) Whether the street trading activity represents, or is likely to represent a substantial risk of nuisance or misbehaviour, particularly in residential areas.
- (b) Whether the granting of the application is likely to give rise to nuisances or loss of amenity caused by noise, odour, litter, disturbance or anti social behaviour;
- (c) in respect of an application in an area which is residential and where trading would not normally take place.

- **Appearance of the unit**

- (a) Whether the unit is of a smart appearance and meet the specific qualitative criteria.
- (b) Whether the appearance of the trading unit or structure is compatible with the character of the area in which it is proposed to be situated.

- **Environmental credentials**

- (a) Whether there is a negative impact of the proposed operation on the local environment including street surfaces and materials, power supply, carbon footprint, supply chain, packaging, waste minimisation, waste disposal and waste created by customers. Mitigating measures to minimise the environmental impact of the proposed operation will be taken into account.

- **Traders**

- (a) Whether the traders in hot or cold food hold a current Level 2 Food Hygiene Certificate;
- (b) Whether the granting of a consent for the sale of goods would conflict with those provided by nearby shops or cafes providing similar services;
- (c) Whether the trading in a particular location will conflict with concessions granted to other existing street traders;
- (d) Whether the quality of the goods to be sold and the hours and days for which it is intended to trade are suitable.
- (e) If trading in food, whether the food business has not achieved their food hygiene rating score of 3 or more

- **Suitability of Applicant**

When determining an application for the grant or renewal of a street trading consent or consideration of revoking a Consent, the Council will consider all relevant information relating to the suitability of the applicant to hold such a permission including:

- (a) where the applicant is unsuitable to hold a consent because of having been convicted of an offence that the Council consider makes them unsuitable to hold such consent, or for any other reason (guidance relating to the relevance of convictions is attached at Appendix 9);
- (b) where the applicant has at any time been granted a street trading consent by the Council, and has persistently refused or neglected to pay fees;
- (c) where the applicant or operator of the stall is under the age of 17 years;
- (d) where a trader has failed to comply with the conditions attached to the consent.
- (e) whether any earlier Consent to the applicant(s) has been surrendered, refused or revoked (whether it be in this Authority or other);
- (f) levels of complaints received about the applicant(s) and whether and how such matters were resolved;

(g) the decision may take into account the attitude of the applicant and/or their staff etc in dealing with concerns and queries raised by the Council Officers.

- **Number of Street Trading Consents**

(a) Consents may not be issued where Sheffield City Council considers that sufficient traders already exist in that locality and that additional traders may cause risks to public safety or nuisance to the occupants of neighbouring properties.

- **Objections**

(a) Take into account any objections made about the application or Consent holder from interested parties.

2.8.3 The above is not an exhaustive list and each application will be judged on its own individual merits. Any effective measures offered by the applicant to support the objectives will be taken into account.

2.8.4 The Council may at any time revoke a consent or vary the conditions of an existing consent where there are reasonable grounds for so doing.

2.9 Approval of Applications

2.9.1 The Licensing Committee, or Officers on a delegated basis may approve applications meeting the criteria contained within this Policy.

2.9.2 On approving the application the Council will issue a Street Trading Consent to which conditions will be attached, including specific terms such as days and hours when street trading is permitted, and goods that may be sold. The consent will also be subject to the Council's standard conditions, which are attached to all Street Trading Consents.

2.9.3 The conditions attached to the Consent form part of the approval to carry out street trading in Sheffield and **MUST** be complied with at all times. Failure to do so could constitute an offence and be subject to prosecution, and/or the Consent could be revoked or not renewed.

2.9.4 The applicant will be issued with a Consent and a Certificate along with the conditions.

2.9.5 The consent holder shall at all times have a copy of the consent available for inspection on request to any Police Officer or duly Authorised Officer of the Council.

2.9.6 The certificate must be clearly displayed on the vehicle or stall and must be visible to the public and customers.

2.9.7 The issuing of a Consent does not:

1. Permit trading outside the terms of the Consent.
2. Indicate that planning permission is not required.

- (a) That the requirement to obtain planning permission applies to all streets, whether they have been designated Consent Streets or not.
 - (b) That the grant of one or more street trading consents does not give the trader immunity from planning control
 - (c) The Council has discretion whether or not to enforce planning laws in relation to street trading.
3. Indicate that the unit is exempt from business rates
 4. Over ride parking restrictions or any other traffic regulations
 5. Imply approval from the highway authority or any other person or authority

3.0 PART 3 – STREET TRADING CONSENTS

3.1 City Centre Street Trading

- 3.1.1 This scheme is part of the City Council's campaign to make Sheffield City Centre a more attractive and vibrant place and offer to create a continental feel to the city.
- 3.1.2 The city centre area in relation to Street trading is attached at Appendix 10, if you wish to trade within this area applicants must apply appropriately as below.
- 3.1.3 The applicant must meet the city centre qualitative criteria (Appendix 6) which forms the basis on which to test applications for the grant of designated Street Trading Consent sites within the city centre.
- 3.1.4 Motorised vehicles or stalls etc. are not permitted as part of the city centre scheme and we encourage barrows/handcarts to be used.
- 3.1.5 All barrows/handcarts must be capable of being moved on and off site by hand and any vehicles used to bring the barrows/handcarts to the site must be parked, loaded and unloaded off site.
- 3.1.6 Specific areas have been allocated for the city centre and applicants are advised to contact the Licensing Service for an up to date list.
- 3.1.7 The fees for city centre sites that are part of this scheme have been set at £498.50 per quarter (£1,994 per annum) to trade seven days a week between 7am and 7pm (fees are reviewed annually).
- 3.1.8 All city centre consents expire on the 30th November each year.
- 3.1.9 All applications will be dealt with under their own individual merits, however, when determining an application the proximity of existing nearby shops, café's and other traders that primarily trade in the same articles will be taken into account.
- 3.1.10 Applicants would be required to submit the appropriate application form with an example of the proposed type and design of trading unit with a non-refundable fee of £100 to process the application. If granted the £100 will be deducted from the next quarterly payment.
- 3.1.11 Applicants are advised not to purchase any trading unit prior to an application being approved.
- 3.1.12 A twenty eight day consultation period will commence from the day we receive the applications and follow the consultation process detailed in section 2.6 above.
- 3.1.13 All applications will then be placed before our Licensing Committee for determination and applicants are advised to provide as much information as possible regarding their proposal which can include photographs of the proposed

barrow/cart, designs, lettering, colours, uniforms etc as part of the application and presentation to the Committee.

3.2 Static Street Traders

- 3.2.1 Static street trading is trading in one site for **more** than 20 minutes. If a trader wishes to move around various parts of the city they are required to apply for the appropriate mobile street trading consent.
- 3.2.2 Static street trading is where a pitch is identified and a consent holder trades only from that pitch within the terms and conditions of the consent issued.
- 3.2.3 These pitches are usually very specific and traders are given consent based on the **detailed** plan submitted on application.
- 3.2.4 It would be up to the trader to locate a pitch and make an appropriate application with the Authority.
- 3.2.5 Applicants must contact the Highways and Planning services prior to submitting an application to discuss any issues they may have and whether any other permissions are required.
- 3.2.6 It is not possible for traders to move pitch, even just a short distance, without the prior consent of the Licensing Service.
- 3.2.7 All static street trading consents expire on the 30th November.
- 3.2.8 All applications will be dealt with under their own individual merits, however, when determining an application the proximity of existing nearby shops, café's and other traders that primarily trade in the same articles will be taken into account.
- 3.2.9 Applicants must follow the application procedure as detailed in section 2.5 of this policy.
- 3.2.10 For new static applications, the application will be advertised detailing the proposed activities in the vicinity, by posting a notice at or close to the proposed site stating:
- the name of the applicant,
 - type of vehicle or stall to be used and the goods to be sold,
 - the times and days of operation,
 - the exact location of the proposed site,
 - how to make representations and the final date by which representations can be made.
- 3.2.11 Written comments from consultees, individuals and occupiers of properties that may be affected by the proposed site will be taken into consideration when determining an application.
- 3.2.12 Any representations will be considered and placed before the Licensing Committee for determination.

- 3.2.13 Please note: all stalls/units will be inspected prior to issuing a consent to ensure it complies with the qualitative criteria.
- 3.2.14 Static street trading consents may require planning consent to be obtained. It is essential that you contact the planning section to check whether a planning consent is required **before** you begin operating under any street trading consent.
- 3.3 Mobile Street Trading for Fruit and vegetable traders
(This section does not include ice cream traders).**
- 3.3.1 Mobile consents are issued to traders who want to trade from numerous locations for a short period of time.
- 3.3.2 Mobile traders who sell fruit and vegetables only will move from site to site and will only remain stationary for no longer than 20 minutes for sales to be made and must not return to that site within the same week (site refers to a 500 metre radius).
- 3.3.3 Any consent issued under this section for a mobile street trader does not permit the holder to trade within an 800 metre radius of the Sheffield Arena, Don Valley Stadium, Sheffield Wednesday and Sheffield United Stadiums on any event / match day for four hours previous, during and one hour after any event. See Appendix 11, 12, 13 and 14.
- 3.3.4 Mobile traders for fruit and vegetable traders are only permitted to trade within the hours of 9am to 7pm inclusive seven days a week.
- 3.3.5 Mobile traders fruit and vegetable traders cannot stop within 800 metres of any school from an hour before the start of the school day until an hour after the end of the school day.
- 3.3.6 Mobile consent holders for fruit and vegetables are not permitted to trade within a 500 metre radius of any static traders, other mobile traders, or shops, trading in similar goods / articles.
- 3.3.7 In order to regulate and control mobile street trading in Sheffield, the trader will only be permitted to trade in a maximum of 5 areas in the City for each consent. The Licensing Committee may at any time wish to restrict the number of traders in a particular area.
- 3.3.8 Mobile trading vans in this section are required to have a side hatch to serve customers to avoid obstruction and are required to ensure that any foods that require refrigeration are installed with adequate units to meet food safety requirements.
- 3.3.9 Applicants must follow the application procedure as detailed in section 2.5 of this policy and ensure they meet the qualitative criteria.
- 3.3.10 Once received the Licensing Authority will consult as stated in section 2.6 above for a period of 28 days.

3.3.11 Any representations will be considered and placed before the Licensing Committee for determination.

3.3.12 All mobile street trading consents expire on the 31st March.

3.3.13 Please note: all vehicles will be inspected prior to issuing a consent to ensure it complies with the qualitative criteria.

3.4 Mobile Street Trading (ice cream traders only)

3.4.1 Ice cream mobile consents are issued to those who want to trade from numerous locations for a short period of time around the city excluding the city centre and areas listed below.

3.4.2 Ice cream mobile traders will move from site to site and will only remain stationary for no longer than **20** minutes for sales to be made and must not return to that site within the same day (site refers to a 400 metre radius)

3.4.3 Any consent issued for an ice cream mobile street trader does not permit the holder to trade within an 800 metre radius of the Sheffield Arena, Don Valley Stadium, Sheffield Wednesday and Sheffield United Stadiums on any event / match day for four hours previous, during and one hour after any event. See Appendix 11, 12, 13 and 14.

3.4.4 Ice cream mobile traders are only permitted to trade within the hours of 9am to 7pm inclusive unless with prior written consent of the Licensing Authority.

3.4.5 Ice cream mobile traders cannot stop within 800 metres of any school from an hour before the start of the school day until an hour after the end of the school day unless you have applied for a school street trading consent as referred to below in section 3.5.

3.4.6 Applicants must follow the application procedure as detailed in section 2.5 of this policy.

3.4.7 Once received the Licensing Authority will consult as stated in section 2.6 above for a period of 28 days.

3.4.8 Any representations will be considered and placed before the Licensing Committee for determination.

3.4.9 All mobile street trading consents expire on the 31st March.

3.4.10 Please note: all vehicles will be inspected prior to issuing a consent to ensure it complies with the qualitative criteria.

3.5 School Street Trading

- 3.5.1 School street trading is where a trader parks outside or near a school from Monday to Friday during school term times from 12.00 noon until 2.00 pm and 3.00 pm until 4.30 pm.
- 3.5.2 To be eligible to apply for a school street trading consent, you must hold an ice cream mobile street trading consent as listed in section 3.4 above.
- 3.5.3 Applicants are required to obtain written confirmation from the head teacher of the school they wish to trade outside from. This written confirmation must be on school headed paper and will not be accepted in any other form.
- 3.5.4 Applicants must follow the application procedure as detailed in section 2.5 of this policy.
- 3.5.5 The application will be consulted upon in the normal way within the 28 day period. Applicants are advised to contact the Highways and Planning service prior to submitting their application to discuss any issues and whether any other permissions are required.
- 3.5.5 Any representations will be considered and placed before the Licensing Committee for determination.
- 3.5.6 For information: Sounding of Chimes (Based on the National Code of Practice)
- Chimes and other audible signals should not be sounded:
- For longer than 4 seconds at a time – an automatic cut out should be used.
 - When the vehicle is stationary.
 - Except on approach to a selling point.
 - When in sight of another mobile trader.
 - Louder than 80 dB(A) at 7.5m.
 - Before 12:00 or after 19:00 hours

3.6 Football Street Trading

- 3.6.1 Street trading is restricted around Sheffield's football grounds and any trader wishing to trade within an 800 metre radius of either ground on match days will be required to apply for a football street trading consent.
- 3.6.2 A plan indicating the radius of Sheffield Wednesday Football Club is attached at Appendix 11.
- 3.6.3 A plan indicating the radius of Sheffield United Football Club is attached at Appendix 12.
- 3.6.4 Granted football consents will be permitted to trade at all 1st Team Home Fixtures, Friendly's & Internationals for four hours prior, during and up to one hour after each fixture for that particular ground.

- 3.6.5 Restrictions have been placed on the number of consents that are issued at each stadium in order to avoid over-crowding, congestion and conflict between traders.
- 3.6.6 The following indicate the maximum consents permitted around both grounds:
- Sheffield Wednesday Football Ground - 19 consents
 - Sheffield United Football Ground - 15 consents
- 3.6.7 Any applications for new consents beyond the restricted numbers referred to above shall be placed before the Licensing Committee for determination.
- 3.6.8 Additional consents are only likely to be granted by the Licensing Committee if the applicant can demonstrate to the Committee that the unit will be a minimum of 25 metres away from any other current consent holder and that the consent site applied for does not cause any obstruction, to footpaths or exit routes from the stadia.
- 3.6.9 Consents may be restricted to trading prior to fixture on advice of the Police.
- 3.6.10 Applicants must follow the application procedure as detailed in section 2.5 of this policy.
- 3.6.11 The application will be consulted upon in the normal way within the 28 day period. Applicants are advised to contact the Highways and Planning service prior to submitting their application to discuss any issues and whether any other permissions are required.
- 3.6.12 Any representations will be considered and placed before the Licensing Committee for determination.

3.7 Short term Street Trading Consents

- 3.7.1 Short term consents for static street trading can be applied for the following periods:
- 1 month
 - 1 week
 - 1 day
- 3.7.2 The application period for these short term consents are no different to a static application (section 3.2), so applicants are reminded to ensure their applications are made in good time.
- 3.7.3 For 1 day consents, we will endeavour to determine your application within 28 days.

3.8 Applicants and Assistants

- 3.8.1 In order to control persons working at a consent site, the Licensing Authority will issue an identity badge to the person applying for the consent and will require the applicant to identify any person that is to work under his permission.

- 3.8.2 Consent holders must ensure that any person who is working on a street trading consent site has obtained the relevant authorisation in the form of an identification badge from the Licensing Service.
- 3.8.3 Application forms are available from the Licensing Service and the completed form needs to be submitted with two (recent and identical) passport size photographs signed and dated on the reverse as a true likeness, the required fee and any other documentation requested on the application.
- 3.8.4 Applications for an identification badge need to be made by the consent holder and all other persons who wish to work at the consent site (assistants).
- 3.8.5 The identification badges must be worn at all times by the person(s) working at the consent site.
- 3.8.6 No person(s) may work at the consent site until they have been issued an identification badge by the Licensing Service.
- 3.8.7 No person(s) under the age of 17 are permitted to work at a street trading consent site as under the Children and Young Persons Act 1933, as amended by the Children and Young Persons Act 1963.

3.9 Renewals

- 3.9.1 Street Trading Consents are generally issued for a period of up to one year.
- 3.9.2 Applicants must then re-submit their application if they wish to continue to trade at least two months before the expiry of their current consent. At this renewal time, the Council may consult further to determine if the street trader is a cause for concern or has been the subject of complaints.
- 3.9.3 If a renewal is not made before the expiry of the current licence, a new application will have to be made, complete with consultation. (A trader will not be permitted to trade until the new consent is issued.)
- 3.9.4 Where a renewal application has been made and there have been no justifiable complaints, no enforcement issues and all fees have been paid on time, the consent will be renewed.
- 3.9.5 Where a renewal application has been made and there have been complaints or enforcement issues or fees have not been paid on time, then the application will be referred to the Licensing Committee.

3.10 Annual Static Consents with Quarterly Payments

- 3.10.1 The Council acknowledge that the cost of an annual consent can sometimes prove prohibitive to new and small street trading businesses, particularly food and drink vendors. To assist such commercial activity the Licensing Authority will offer the grant of a twelve month Static Street Trading Consent, subject to quarterly fee payments in advance.

- 3.10.2 All static consents expire on the 30th November each year and quarterly payments will be required in advance of each quarter. Reminders will be issued, however it would be up to applicant to ensure payment is made at the required time. Payments are normally due in November, February, May and August.
- 3.10.3 If payments are not made, the consent will automatically cease to have effect, save for exceptional circumstances at the Council's discretion, and no further trading in connection with that consent will be permitted until payment has been made.
- 3.10.4 The Council may remove the entitlement of quarterly payments at any time if payments are not received promptly.

3.11 Transfers

- 3.11.1 A Street Trading Consent cannot be transferred or sold to another person (Consent may be transferred to a member of the Consent Holder's immediate family in the event of the Consent Holder's death).
- 3.11.1 The sub letting of a pitch is prohibited.

3.12 Variations

- 3.12.1 Variations of a Street trading consent can be made for the following purposes:
- Change of vehicle / unit.
 - Change of hours (only on static applications).
 - Days of trading.
 - Change of items to be sold.
- 3.12.2 The application must be made on the Council's prescribed application form along with the fee and any necessary supporting documentation.
- 3.12.3 A change of minor details can be made in writing with supporting documentation with a nominal fee for example:
- Change of existing consent holders name (not a transfer).
 - Removal of an existing consent holder on a joint application.
- 3.12.4 Variations for the following will **not** be permitted and will require a new application:
- Change of Consent holder.
 - Adding a new Consent holder.
 - Change of site(s).

4.0 PART 4 – CONDITIONS AND ENFORCEMENT

4.1 Conditions and Enforcement

- 4.1.1 Standard conditions will be attached to each street trading consent detailing the holder's responsibilities to maintain public safety, avoid nuisance and generally preserve the amenity of the locality.
- 4.1.2 Applicants will be required to sign a declaration confirming that they understand and agree to fully comply with the conditions prior to the granting of a consent.
- 4.1.3 The Council is committed to enforcing the provisions contained within the relevant legislation and to work in partnership with all enforcement agencies, to provide consistent enforcement on licensing issues.
- 4.1.4 Where licensable activities are conducted without the benefit of a consent or where conditions are breached, the Council will look to gather evidence and take enforcement action as appropriate.
- 4.1.5 Any enforcement action will be
- **Proportionate** in applying law and seeking compliance.
 - **Consistent** in approach.
 - **Targeted** towards applicants not complying with their consent or conditions or unlawful activity.
 - **Transparent** in helping applicants and consent holders to understand what is expected of them.
- 4.1.6 If the Council feels that there is an issue of public order or threat to public safety in any particular instance, it will call for assistance from South Yorkshire Police.
- 4.1.7 The Council may also call for assistance from the CCTV control room when dealing with such issues.
- 4.1.8 Should a street trader fail to comply with instructions received from an Authorised Officer or Police Officer, the consent will be referred to the Licensing Committee.

5.0 PART 5 – OTHER LEGISLATION

5.1 Planning Permission

5.1.1 If a street trading consent is applied for, the onus is on the applicant to obtain both planning permission and permission to trade from the landowner when necessary, prior to making an application for street trading consent. It is not the responsibility of the Council to investigate and obtain this information.

5.2 Licensing Act 2003

5.2.1 In addition to the requirement of having a street trading consent, applicants who sell hot food or hot drinks between 23.00 hours and 05.00 hours the following day will require a premises licence under the Licensing Act 2003. The Licensing Service is able to provide advice as to the application process.

5.2.2 For traders that seek to trade only between the hours of 23.00 hours and 05.00 hours, a street trading consent will still be required in addition to the Licensing Act premises licence. A consent will not be granted without a premises licence being applied for.

5.2.3 Full details on how to apply for a premises licence can be collected from the Licensing Service or on our website at www.sheffield.gov.uk/licensing.

5.3 Traffic Regulation Orders

5.3.1 Applicants need to be aware of any parking restrictions (yellow lines) and other traffic restrictions on the highway when deciding where to site their vehicle.

5.3.2 If an applicant thinks there is a traffic regulation order that might affect their consent, they must contact the traffic regulations section on (0114) 273 6178 or email Traffic_Regs@sheffield.gov.uk before an application is submitted.

5.4 Food Establishments

5.4.1 Food establishments must be registered with Environmental Health (contact (0114) 273 5774 / 273 4415 or email healthprotection@sheffield.gov.uk).

5.4.2 It is a criminal offence to operate a food business without being registered.

5.4.3 There is no charge for registration.

5.5 Trade Waste Disposal

5.5.1 Applicants have a legal responsibility under the Environmental Protection Act 1990 and other related legislation to safely contain and legally dispose of any waste produced from your business.

5.5.2 Applicants may be prosecuted should they not comply with the above requirements.

5.5.3 For further information on this, please contact Environmental Protection on 0114 2037411 or visit www.netregs.gov.uk.

6.0 PART 6 – USEFUL INFORMATION AND CONTACT DETAILS

6.1 Authorities

- **The Licensing Authority**

Licensing Service
Sheffield City Council
Business Strategy & Regulation
Block C, Staniforth Road Depot
Sheffield, S9 3HD

Tel: 0114 203 7752
Fax: 0114 273 4073
Email: general.licensing@sheffield.gov.uk
Website: www.sheffield.gov.uk/licensing

You can also visit our reception service at Staniforth Road Depot where you can discuss your query with one of our Licensing Officers. The Licensing Service is open Monday to Friday 9:00am to 5:00pm.

- **The Planning Authority**

Tel: 0114 203 9183
Email: planningdc@sheffield.gov.uk
Website: www.sheffield.gov.uk/planning

- **The Highways Department**

Tel: (0114) 273 6677
Email: highways@sheffield.gov.uk
Website: www.sheffield.gov.uk

- **City Centre Management Team**

Tel: (0114) 2736895
Email: citycentre.management@sheffield.gov.uk
Website: www.sheffield.gov.uk

- **South Yorkshire Police**

You will need to contact the station in the area you wish to trade

Tel: (0114) 220 2020
Website: www.southyorks.police.uk

- **South Yorkshire Fire and Rescue**

Tel: (0114) 272 7202
Website: www.syfire.gov.uk

- **Food Hygiene**

Tel: (0114) 273 5774 / 273 4415

Email: healthprotection@sheffield.gov.uk

Website: www.sheffield.gov.uk

- **Food Registration**

Tel: (0114) 273 5774 / 273 4415

Email: healthprotection@sheffield.gov.uk

Website: www.sheffield.gov.uk

6.2 First Point for Business

Town Hall
Pinstone Street
Sheffield, S1 2HH

Tel: (0114) 224 5000

Email: firstpointforbusiness@sheffield.gov.uk

Website: www.sheffield.gov.uk

Information is available for anyone considering setting up a new business or would like help or advice regarding an existing business.

If you are starting up a new business or are an established business needing advice, you can access help from the Council's First Point for Business.

Anyone can use First Point for Business – from companies to social enterprise to self-employed people.

First Point for Business is your one point of contact with the Council for all your business needs. If you are setting up a new business, for example, you may need to speak to Licensing, Planning, Highways and a number of other Council services.

The First Point for Business team is on hand to help you access Council services and specialist advice, so you get all the support you need. If you need practical business support such as start up advice, business planning, marketing or workforce training and skills they will put you in touch with the right people.

First Point for Business work on your behalf. You will deal with a Key Account Advisor who will identify your needs and help you get the right information and advice.

If they cannot give you all the answers straight away, then they will do the leg work and get back to you.

The Key Account Advisors will also help you to find out about the advice and support you could receive from outside the Council.

You are welcome to visit in person at the First Point for Business office in the Town Hall, just contact them for an appointment or simply drop in.

There is also wireless broadband in the First Point for Business office, so you can use your own laptop if needed.

APPENDIX 1 - SHEFFIELD BOUNDARY MAP

Sheffield: Administrative Boundary

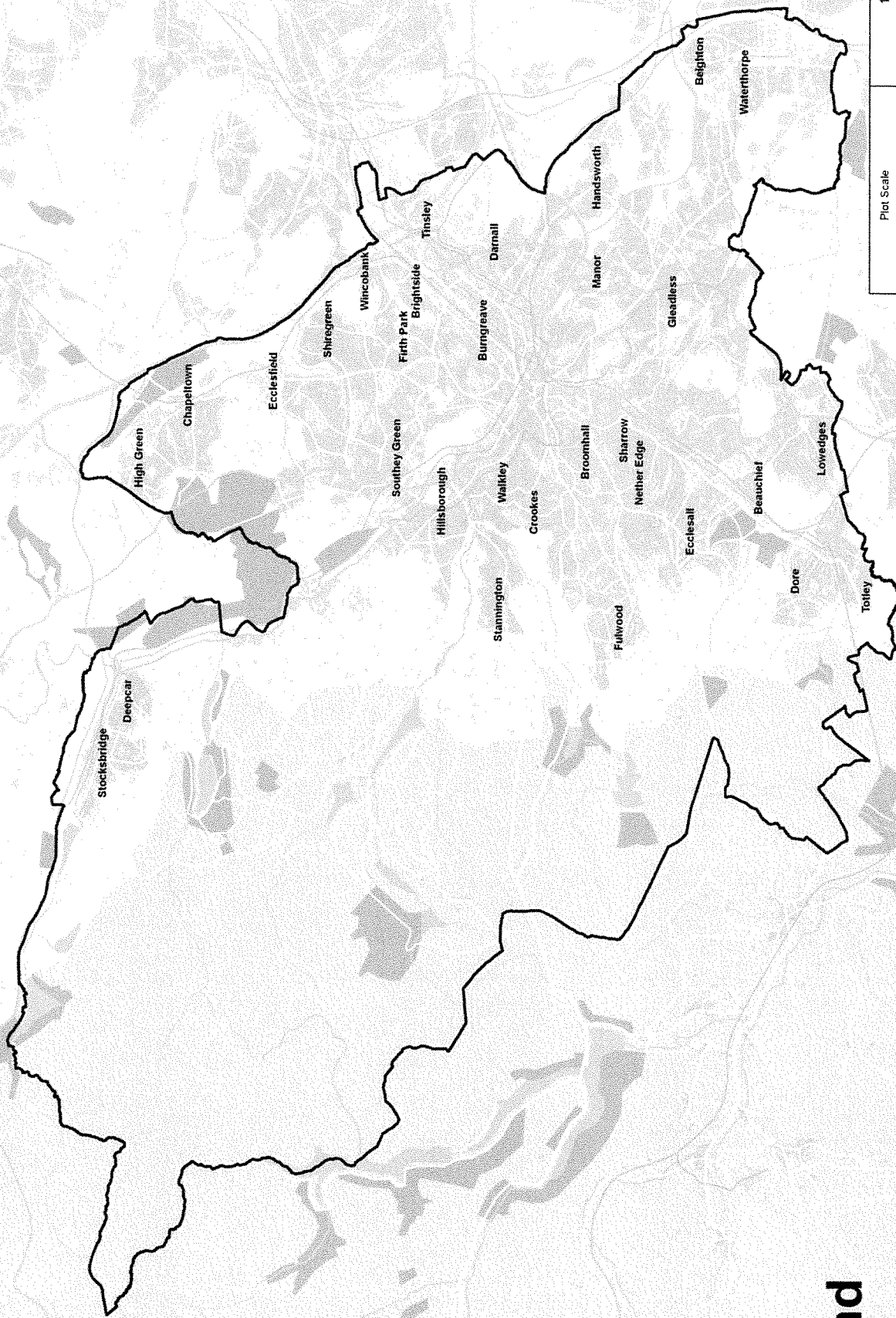

Plot Scale 1:95,000

Sheffield City Council
Policy & Research
Deputy Chief Executives Directorate
Town Hall
Pinstone Street
Sheffield S1 1UL
Tel: (0114) 2930239

Legend

 City Boundary

SHEFFIELD CITY COUNCIL

LOCAL GOVERNMENT (MISCELLANEOUS PROVISIONS) ACT 1982

Standard Street Trading Consent Conditions

AUTHORISATION

1. The consent is only valid for the person named and is not transferable.
2. This consent enables the holder to trade in Sheffield from the area designated and between those times detailed in this consent only (if any).
3. The consent holder shall at all times have a copy of this consent available for inspection on request to any Police Officer or duly Authorised Officer of the Council.
4. A certificate will be issued along with the consent which must be clearly displayed on the vehicle or stall in a position that is clearly visible to customers and members of the public.
5. The consent holder shall only trade from the size and type of vehicle / stall / trailer specified in this consent.
6. The consent holder shall not use or permit anyone to use this consent to trade from anywhere other than the site detailed within this consent.
7. The consent holder shall ensure that a current price list of articles being sold is always prominently displayed on the vehicle or stall.
8. There shall be no alteration in the design / construction / appearance of the vehicle or stall without the written permission of the Council having been obtained.
9. There shall be no change in the range of articles sold without the written permission of the Council having been obtained.
10. The consent holder shall at all times have available for inspection an up to date and valid Certificate of Insurance (Vehicle and Public Liability) – the level of Public Liability Cover shall be a minimum of £2,000,000.
11. The Council reserve the right, should the need arise from time to time, to direct that the consent holder shall not trade:
 - from the whole or any part of the site;
 - during certain times from the site;
 - and move to an alternative site for a small length of time;and the consent holder shall comply with that instruction.
12. In the event that the Council give a direction to cease trading from the whole of the site, the City Council shall deduct from the next fee instalment due, a sum

proportional to the trading time lost. For the purposes of this calculation it shall be deemed that trading takes place on 7 days a week.

13. This consent will expire on the date given on the face of this consent, and the Council are under no obligation to renew such consent.
14. Consent holders shall notify the Council in writing of any permanent change of address as soon as it occurs. You must provide proof of your new address with your notification (i.e. utility bill, bank statement, etc.)
15. Consent holders shall ensure that disabled people and wheelchair users can be adequately served.

CONDUCT

16. Consent holders and any assistants employed by them shall ensure the public and Council officers are treated fairly and with courtesy. Traders shall ensure that their staff are competent, courteous and helpful.
17. Consent holders will not obstruct Authorised Officers of the Council or Police Officers at any time and will always be polite and courteous.

AREA

18. Any consent issued by the Licensing Service does not permit the holder to trade within "The City Centre Boundary" unless specifically stated.
19. Any consent issued for a street trader does not permit the holder to trade within 800 meter radius of any school in the Sheffield boundary unless authorised to do so.
20. Any consent issued for a mobile street trader does not permit the holder to trade within an 800 metre radius of the Sheffield Arena, Don Valley Stadium, Sheffield Wednesday and Sheffield United Stadiums on any event / match day (see plan for radius) for four hours previous, during and one hour after any event.

ASSISTANTS

21. The consent holder will only employ persons that are suitably qualified in food hygiene to assist him (unless trading in non food articles / goods).
22. The consent holder shall not permit any person under the age of 17 to engage in Street Trading.
23. The consent holder shall ensure that any person who is working on the vehicle, stall or designated area has obtained the relevant authorisation and is wearing the identity badge issued to them by the Council (this includes the consent holder and any other person who is assisting the consent holder in trading).
24. The consent holder shall ensure that any person who is working on the vehicle has a right to work in the UK and has made appropriate checks.

25. The consent holder shall ensure that the Council (Licensing Service) are informed immediately of any new assistants that are employed to work at the vehicle, stall or unit.
26. The consent holder shall supply a copy of these street trading conditions to every assistant employed by him and ensure they are fully aware of their responsibilities.

FOOD HYGIENE

27. The consent holder shall at all times observe proper food safety and hygiene standards and shall make appropriate use of any equipment provided for this purpose.
28. The applicant shall comply with all statutory requirements regarding food hygiene. The applicable legislation is:

**FOOD HYGIENE (ENGLAND) REGULATIONS 2006
FOOD REGULATIONS (EC) 852/ 2004.**

29. In accordance with the food hygiene legislation the applicant must provide proof to the Council that the business/mobile food unit is currently registered with the food authority in which the stall, handcart, barrow or mobile food unit is currently stored.
30. The applicant together with all other persons employed in food handling activities are required to attend a food hygiene course commensurate with the food handling activities.
31. Food traders must meet a minimum of 3 in their food hygiene rating score.
32. The applicant must display their food hygiene rating score visibly to customers.

LEGAL PROVISIONS

33. Nothing contained in these conditions shall relieve or excuse the consent holder or their employees or agents from any legal duty or liability and at all times the consent holder shall comply with the relevant legislation in force.

GENERAL

34. The consent holder shall take all reasonable steps to ensure public safety; in particular, any vehicle or trailer used to assist in street trading shall be maintained in a safe condition and be tested / serviced annually.
35. The consent holder shall ensure that no waste liquids (including grease) of any description are deposited on to the site, highway or into rainwater gullies / drains serving the site. All liquids must be removed from the site and disposed of in a proper manner.
36. The consent holder shall take all reasonable steps to;
 - Prevent accumulation of litter dirt, and / or grease in or close to the site;
 - Remove and properly dispose of any such litter, etc which does accumulate.

See www.netregs.gov.uk or contact Environmental Protection on 0114 2037411 for more information on Trade Waste Disposal.

37. No freestanding advertisements such as 'A' boards or signs attached to street furniture will be permitted.
38. The consent holder shall comply with any reasonable request and / or instruction given to him / her by a Police Officer or duly Authorised Officer of the Council.
39. The consent holder shall not use or permit to be used any electrical or electronic equipment (for example, televisions or radio receivers) in such a manner as to cause a disturbance and or nuisance.
40. The consent holder shall not obstruct the highway / footpath in which the site is situated or cause danger to persons using the highway / footpath.
41. The consent holder shall not cause nuisance or annoyance whether to persons using the street or otherwise.
42. The consent holder shall be responsible for and reimburse the Council in respect of any damage he / she causes to the highway / footpath or any fittings or fixtures on it.
43. The consent holder shall at all times obey all road traffic regulations in force in the consent area.
44. The consent holder and/or assistant must notify the Council immediately of any convictions or proceedings arising out of the use or enjoyment of the Consent, or from any other offence committed.

PLEASE NOTE, for the purposes of these conditions the "Council" shall be defined as the Licensing Service.

I confirm I have read and understood the conditions attached to my consent and will undertake to comply with all conditions:

Signed:.....

Print name:..... Dated:.....

SHEFFIELD CITY COUNCIL

LOCAL GOVERNMENT (MISCELLANEOUS PROVISIONS) ACT 1982

Ice Cream Mobile Street Trading Consent Conditions

1. Mobile consent holders are not permitted to remain static for more than 20 minutes, and cannot return to the same site within the same day (site refers to a 400 metre radius).
2. Mobile consent holders are not permitted to trade within a 400 metre radius of any static traders, other mobile traders, or shops, trading in similar goods / articles.
3. Any consent issued for a mobile street trader does not permit the holder to trade within an 800 metre radius of the Sheffield Arena, Don Valley Stadium, Sheffield Wednesday and Sheffield United Stadiums on any event / match day for four hours previous, during and one hour after any event.
4. Mobile traders can only trade between the hours as specified on the face of individual consents.
5. Mobile traders are only permitted to trade in the areas listed on their consents.
6. Mobile traders must ensure that any stopping position does not infringe any parking or traffic requirements or cause obstruction of the highway, and does not present any dangers to other road users or pedestrians.
7. Mobile traders must not stop within 800 metres of any school from an hour before the start of the school day until an hour after the end of the school day unless granted a school consent for that site.

PLEASE NOTE, for the purposes of these conditions the "Council" shall be defined as the Licensing Service.

I confirm I have read and understood the conditions attached to my consent and will undertake to comply with all conditions:

Signed:.....

Print name:..... Dated:.....

SHEFFIELD CITY COUNCIL

LOCAL GOVERNMENT (MISCELLANEOUS PROVISIONS) ACT 1982

**Mobile Street Trading Consent Conditions
Fruit and vegetable traders**

1. Mobile consent holders are not permitted to remain static for more than 20 minutes, and cannot return to the same site within the week (site refers to a 500 metre radius).
2. Mobile consent holders are not permitted to trade within a 500 metre radius of any static traders, other mobile traders, or shops, trading in similar goods / articles.
3. Any consent issued for a mobile street trader does not permit the holder to trade within an 800 metre radius of the Sheffield Arena, Don Valley Stadium, Sheffield Wednesday and Sheffield United Stadiums on any event / match day (see attached plan) for four hours previous, during and one hour after any event.
4. Mobile traders must not in any circumstance unload items for sale off the unit for display on the footpath, highway or any other area.
5. Mobile traders can only trade between the hours of 9am to 7pm seven days a week.
6. Mobile traders are only permitted to trade in the areas listed on their consents.
7. Mobile traders must ensure that any stopping position does not infringe any parking or traffic requirements or cause obstruction of the highway, and does not present any dangers to other road users or pedestrians.
8. Mobile traders must not stop within 800 metres of any school from an hour before the start of the school day until an hour after the end of the school day.

PLEASE NOTE, for the purposes of these conditions the "Council" shall be defined as the Licensing Service.

I confirm I have read and understood the conditions attached to my consent and will undertake to comply with all conditions:

Signed:.....

Print name:..... Dated:.....

SHEFFIELD CITY COUNCIL

LOCAL GOVERNMENT (MISCELLANEOUS PROVISIONS) ACT 1982

Static Street Trading Consent Conditions

1. The consent holder shall only trade from the site specified in this consent.
2. Consent fees where previously agreed are payable quarterly in advance of the period to which they relate.
3. The trader shall collect and properly dispose of all wrappings and litter within a 100 metre radius of the site (and beyond where it is the result of the trader's activities from the site) at the end of each trading day and as often as may be necessary during each trading day so as to keep and leave the street in a clean and tidy condition.
4. The consent holder shall comply with all the conditions attached to their consent.

PLEASE NOTE, for the purposes of these conditions the "Council" shall be defined as the Licensing Service.

I confirm I have read and understood the conditions attached to my consent and will undertake to comply with all conditions:

Signed:.....

Print name:.....Dated:.....

CITY CENTRE STREET TRADING Small Trading Stalls

BACKGROUND

Street activities are an essential ingredient of a vibrant and lively city, and in Sheffield there is a strong demand for legitimate small scale trading pitches. They also offer an opportunity for small businesses to get started with relatively modest outlay.

The widening of footways offers the opportunity to designate more pitches in locations that will add to the attractiveness of the City Centre. In Orchard Square and Meadowhall 'Barrow' style stalls are used extensively, enhancing the colour and vitality of those places.

This scheme is part of the City Council's campaign to make Sheffield City Centre a more attractive and vibrant place. Set out below is the qualitative criteria which forms the basis on which to test applications for the grant of designated small trading stall Street Trading Consent sites within the City Centre.

QUALITATIVE CRITERIA – SMALL TRADING STALLS

GENERAL DESIGN

- There will be no motorised vehicles or stalls etc. permitted as part of this scheme.
- All barrows/handcarts must be capable of being moved on and off site by hand and any vehicles used to bring the barrows/handcarts to the site must be parked, loaded and unloaded off site.
- Good display is an important part of the selling process and top quality presentation encourages purchase and benefits the retailer reputation.
- It is in the best interest of traders to produce a high quality design in their barrows/handcarts. The function of the stall is to identify the trader and add vitality and colour to the immediate area, and reflect the quality, cleanliness and order in their operation. The barrow/stall contributes to the appearance of the street for good or bad, so design matters to everyone who uses the street, as well as the operator.
- Sign writing and scrollwork must be finished to a standard acceptable to the City Council.
- The unit must be visually acceptable to the City Council (this will include the Head of Licensing, City Centre Manager and Planning Service) and be in keeping with the street/area that it is to be located.
- Advertisements on stalls will not be permitted except by permission of the Council in writing and subject to further conditions. The Council shall be the sole judge of what is an acceptable advertisement.
- The Council will reserve the right to not renew any consent where it considers the

product(s) offered by the operator are not in keeping with the requirements of the site and the promotion of the City Centre.

- Non functional elements attached to barrows / handcarts, are not acceptable.
- The general design of the barrow/handcart must meet the requirements of the Council for that location.
- Flame retardant 'skirts' are to be used if necessary, so as to obscure the frame, gas bottle etc. They should be designed to 'unify' the barrow/handcart.
- All equipment, tools, gas bottles etc. must be self contained within the stall/handcart etc.
- Bright colours and a sense of fun are encouraged.
- Finished in flame retardant paint.
- A colour photograph or scale illustration of the proposed handcart must be submitted to the Licensing Service as part of the application process.
- No barrow/handcart should have a frontage greater than 3.0 metres or a width greater than 2.0metre.
- Roofs should be no more than 2.5m above ground level.
- Pitched and curved roofs are encouraged.
- Canopies should be high quality with a feeling of 'permanence'. These could be manufactured from either stretched canvas, or woven material, opaque or light metal materials. Clear plastic awning and extensions to the canopy will not be acceptable.
- Canopies must be maintained and cleaned to a high standard.
- Food traders must ensure that any stall design satisfies the requirement of food safely legislation. Staff must be adequately trained in good hygiene (Basic Food Hygiene Certificate and regular on going training) and records of training must be made available on request.
- Best practise of food hygiene must be adopted by the operator. This covers:
 - Personal hygiene
 - Hand washing
 - Ill health
 - Prevention of contamination
 - Temperature control
 - Temperature monitoring
 - Cleaning
 - Storage and stock rotation
 - Procedures in the event of freezer breakdown
 - Site cleanliness
 - Waste disposal
 - Pest control
 - Quality control
 - First aid facilities
- Food traders must have a minimum food hygiene rating score of 3.

**CITY WIDE STREET TRADING
QUALITY SPECIFICATION
(This specification does not include the city centre)**

UNIT DESIGN

- Good display is an important part of the selling process and top quality presentation encourages purchase and benefits the retailers' reputation.
- It is in the best interest of traders to produce a high quality design both internally and externally in their unit.
- The function of the unit is to identify the trader and add vitality and colour to the immediate area, and reflect the quality, cleanliness in their operation. The unit must contribute to the appearance of the area for good or bad, so design matters to everyone who uses the street, as well as the operator.
- Stalls must enhance the visual appearance of the street rather than detract from it and be constructed in a suitable style and of appropriate materials.

Examples of acceptable designs include:

- Modern, simple, functional stalls with umbrellas, canopies or striped awnings.
- Traditional or 'period' type handcarts, barrows or tricycles.
- The stall design should be fully accessible for all customers.
- The outside of the unit will be limited to the name of the stall, the type of product sold and a simple price list. Ad hoc pictures and advertiser's slogans should be avoided, as should untidy handwritten signs.
- Advertisements on stalls will not be permitted except by permission of the Council in writing and subject to further conditions. The Council shall be the sole judge of what is an acceptable advertisement.
- Sign writing and scrollwork must be finished to a standard acceptable to the City Council.
- The unit must be visually acceptable to the City Council.
- The general design of the unit must meet the requirements of the Council for the location and proposed hours or days of trading. A photograph of the actual unit or proposed model must be submitted on application.
- Bright colours and a sense of fun are encouraged.
- Pitched and curved roofs are encouraged.
- Canopies must be maintained and cleaned.

- No expenditure on units or equipment should be made until the Council has granted consent and the unit design has been approved.
- The internal layout of the unit must be clean and to a high standard.
- Non-motorised vehicles (ie carts/barrows) are encouraged in pedestrian areas. For example shopping areas like Woodseats, Hillsborough, etc.
- Mobile trading vans must have a side hatch to serve customers.
- The unit / vehicle must be clearly identifiable as a trader.

Environmental Health considerations of the unit design:

For Enclosed Food units:

- The internal arrangements must be such that:
 - There is suitable and sufficient hand washing facilities with hot water;
 - The work surfaces are impervious to water and readily cleansable;
 - There is sufficient compliant temperature controlled food storage facilities appropriate to the business;
 - The gas and electrical installations are certificated and deemed to be safe by a competent and suitably qualified engineer; any gas store cupboard should be outside of the food area;
- The external arrangements must be that the mobile is sufficiently weather and pest proof so as to not risk the contamination of the food.

For Market-Stall or Street-Barrow type food units:

- The stall must be covered to prevent the risk of matter falling on to the food;
- The work surfaces likely to be in contact with the food must be impervious to water and readily cleansable;
- Any intrinsic storage food area must be able to be secured against the intrusion by pests;
- If temperature controlled food is to be stored on the mobile, the storage facility shall be capable of maintaining the food in a legally compliant manner;
- That there are adequate hand washing facilities.

Food Hygiene record (for all food stalls) - all food regulations have been adhered to:

- The applicant will need to demonstrate that:
 - they have registered with their home Local Authority;
 - all food handlers have received adequate food safety training appropriate to their job role;
 - the food business has a legally compliant Food Safety Management System (e.g. Safer Food, Better Business);
 - if there is a history of non-compliance, it has been addressed and accepted by the Food Safety Enforcing Officer, or that the food business is in the process of addressing the issues and the Food Safety Officer does not consider the defect too severe so as to prohibit the food business from trading; and
 - their business has a food hygiene rating score of at least 3.

DRESS

- Trader and their assistants must be identifiable (i.e wear a uniform).
- The style of dress worn by stall operators should be chosen to complement the style and period of the unit.
- Over clothing must always be smart and clean. Operators of food stalls should ensure that sufficient changes of clothes are provided so as to enable personnel to always wear over clothing, which is clean.
- Personal cleanliness is also important and persons employed at food stalls are required to have good personal hygiene.

GENERAL

- Vehicles used to tow trailers must be parked legally at all times.
- The Council will reserve the right to not renew any consent where it considers the product/s offered by the operator are not in keeping with the requirements of the site.
- The goods complement and do not conflict with the goods sold by other retailers within their proposed area(s).

The criteria above are intended to guide applicants for street trading consents as to the type of stall and dress, which the Council is looking to promote as a means of regulating the street trading.

It is not intended to exclude any design that does not fall within the examples given.

APPENDIX 8 - DELEGATION OF FUNCTIONS

Street Trading Consent

Local Government (Miscellaneous Provisions) Act 1982

Matter to be dealt with	Full Committee	Sub - Committee	Officers
Review of Policy and conditions	In all other cases		Minor changes to policy with agreement of Head of Licensing
Fee setting (where appropriate)	In all other cases		Static Consents
Grant or renewal of a Street Trading Consent		If a representation is made	If no representation made
Variation of a Street Trading Consent		If a representation is made	If no representation made.
Application for an Assistants badge		If a representation is made	If no representation made
Refusal of Consent		In cases where the set conditions or criteria are not met/breached	
Revocation		In all cases	

APPENDIX 9 - GUIDELINES RELATING TO THE RELEVANCE OF CONVICTIONS

Guidelines relating to the relevance of convictions for:

- applicants for the grant or renewal of a street trading consent;
- persons who wish to be registered as an assistant to a holder of a street trading consent or to renew such registration; and
- the holders of street trading consents and persons registered as an assistant to the holder of a street trading consent.

General policy

Each case will be decided on its own merits

1. The Council will assess whether:

- (a) an applicant for the grant or renewal of a street trading consent is a suitable person to hold or to continue to hold a street trading consent,
- (b) a person who wishes to be registered as an assistant to a street trading consent holder or to continue to be registered as an assistant to a street trading consent holder is a suitable person to be registered as an assistant to a street trading consent holder.

In making that assessment, the Council consider the previous convictions of such persons.

2. In considering the previous convictions of those persons mentioned in paragraph 1 above the Council will consider the following:

- (a) whether the conviction is relevant;
- (b) the seriousness of the offence;
- (c) the length of time since the offence occurred;
- (d) whether there is a pattern of offending behaviour;
- (e) whether that person's circumstances have changed since the offence occurred; and
- (f) the circumstances surrounding the offence and the explanation offered by that person.

3. The following is a description of the Council's general approach to certain categories of offences.

a) Dishonesty

The holders of a street trading consent and their assistants have to be persons who can be trusted. It is easy for a dishonest trader or assistant to take advantage of the public.

Members of the public using a street trading outlet expect the holder and his assistant to be honest and trustworthy.

For these reasons a serious view will be taken of any conviction involving dishonesty. In general, an applicant for the grant or renewal of a street trading consent is unlikely be granted a street trading consent where the application is made within 3 to 5 years of a conviction or the date of release from prison.

Similarly a person wishing to be registered as an assistant to a street trading consent holder is unlikely be to be registered where registration is sought within 3 to 5 years from the date of conviction or the date of release from prison.

b) Violence

As street traders and their assistants have close contact with the public, a firm line will be taken with applicants who have convictions for violence. In cases where the commission of an offence involves loss of life, a street trading consent or registration as an assistant to the holder of a street trading consent will normally be refused.

In other cases, a period of 3 to 10 years free of conviction from the date of conviction or the date of release from prison where a custodial sentence has been imposed, depending upon the nature and seriousness of the offence(s), will generally be required before an application is likely to be considered favourably.

c) Drugs

Where an applicant has a conviction for an offence that relates to the supply or importation of drugs and the date of the conviction or the release from prison, where a custodial sentence has been imposed, is less than 5 to 10 years before the date of the application, an application will normally be refused. After 5 years from a conviction or the date of release from prison, where a custodial sentence has been imposed, the circumstances of the offence and any evidence which shows that a person is now a fit and proper person to hold a street trading consent or to be registered as an assistant to the holder of a street trading consent will be taken into consideration.

An application will normally be refused where the applicant has a conviction for an offence relating to the possession of drugs and the date of the conviction or the release from prison, where a custodial sentence for such an offence has been imposed, is within 3 to 5 years of the date of the application. After a period of three years from conviction or the date of release from prison where a custodial sentence has been imposed, consideration will be given to the circumstances of the offence and any evidence to show that an applicant is a suitable person to hold a street trading consent or to act as an assistant to the holder of a street trading consent.

An application will normally be refused where an applicant has more than one conviction for offences related to the possession of drugs and the last conviction or the date of release from prison, where a custodial sentence has been imposed, is less than 5 years before the date of the application.

d) Sexual and indecency offences

As the holders of street trading consents and their assistants, and in particular

those who sell ice cream, have access to children, applicants who have convictions for rape, indecent assault, any sexual offence involving children and any conviction for an offence under the Sexual Offences Act 2003 will normally be refused a street trading consent or registration as an assistant to the holder of a street trading consent.

Where an applicant has a conviction for a sexual offence such as indecent exposure they will normally be refused a street trading consent or registration as an assistant to the holder of a street trading consent until they can show a substantial period usually between 5 and 10 years free of any such convictions from the date of conviction or the date of release from prison where a custodial sentence has been imposed.

After a period of 5 years from conviction or the date of release from prison, where a custodial sentence has been imposed, consideration will be given to the circumstances of the offence and any evidence to show that an applicant is a suitable person to hold a street trading consent or to be registered as an assistant to the holder of a street trading consent.

When considering applications, the Council may take into account any information of a sexual nature which does not amount to a criminal offence that is brought to its attention where that information may indicate that an applicant may not be a suitable person to hold a street trading consent or to be registered as an assistant to the holder of a street trading consent. In cases where the Council considers that information shows an applicant is not a suitable person, it will normally require a period of not less than 5 years free of such incidents from the date on which the incident occurred or, if more than one from the date of the last incident.

e) Motoring convictions

In most cases, motoring offences are unlikely to be relevant when deciding if an applicant for a street trading consent or to be registered as an assistant to the holder of a street trading consent is a suitable person.

However, there may be instances where the offences are of a very serious nature. In those cases, an applicant for a street trading consent or to be registered as an assistant to the holder of a street trading consent would be expected to show a period usually between 3 and 5 years free of any such convictions from the date of conviction or the date of release from prison, where a custodial sentence has been imposed.

f) Formal cautions and fixed penalty notices

For the purposes of these guidelines, the Council will treat Formal Cautions issued in accordance with Home Office guidance and fixed penalty notices as though they were a conviction before the courts

**City Centre Management Team
Boundary and Zones Map**

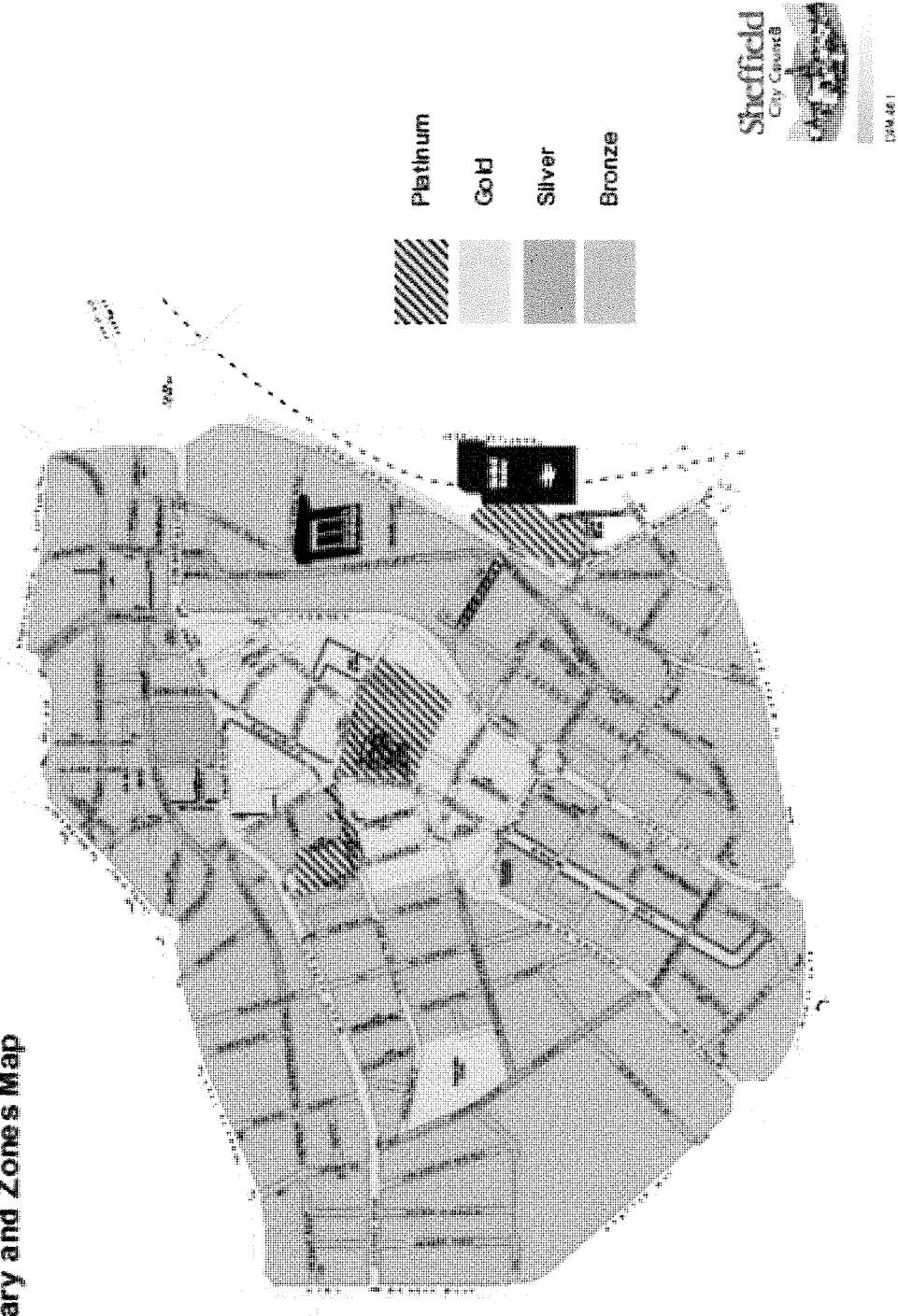

APPENDIX 11

- PLAN AND RADIUS OF SHEFFIELD WEDNESDAY FOOTBALL CLUB

Hillsborough Football Stadium

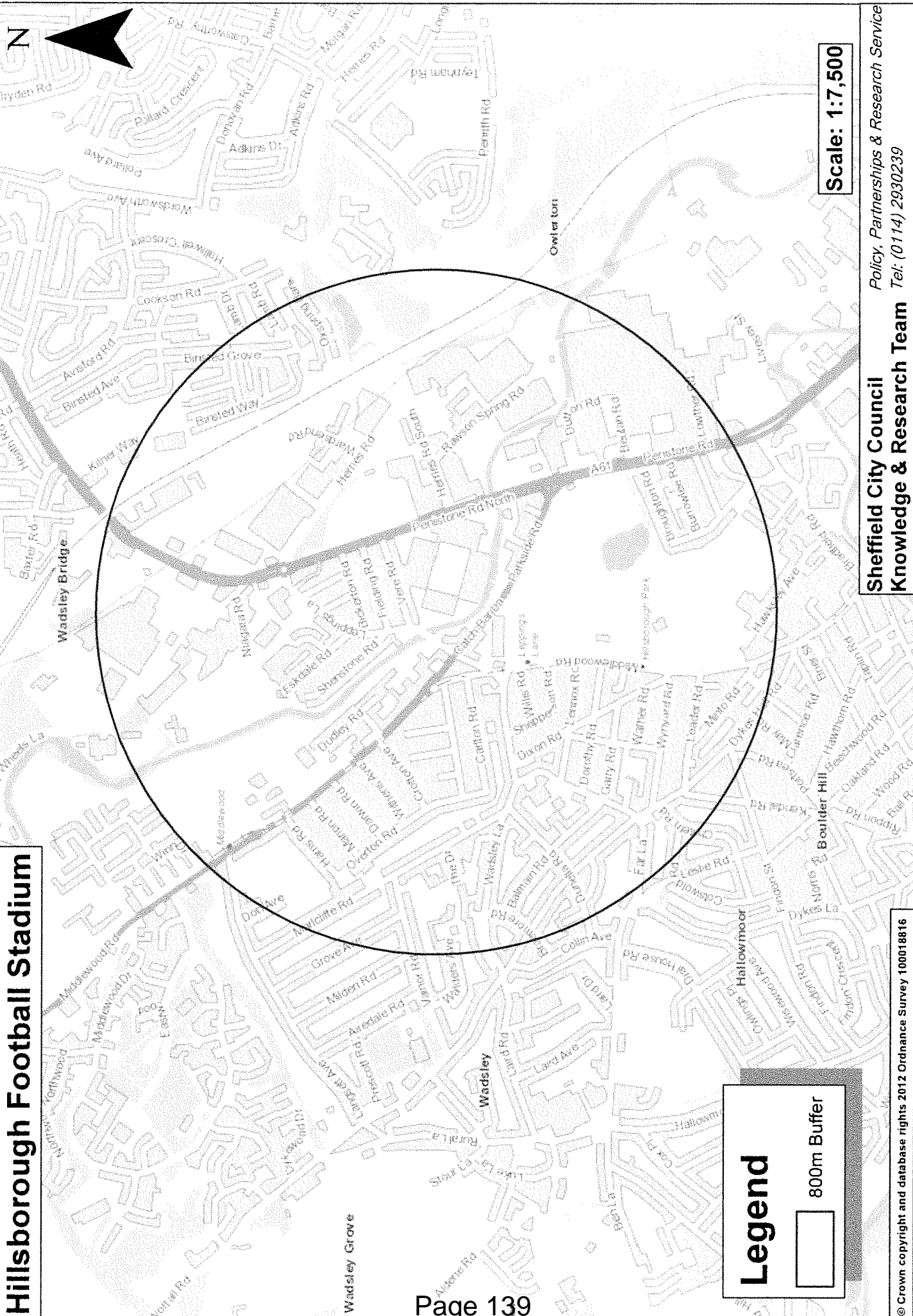

Scale: 1:7,500

Legend

800m Buffer

APPENDIX 12

- PLAN AND RADIUS OF SHEFFIELD UNITED FOOTBALL CLUB

Bramall Lane Football Stadium



Scale: 1:7,500

Legend

- 800m Buffer

Sheffield City Council
Knowledge & Research Team

Policy, Partnerships & Research Service
Tel: (0114) 2930239

Don Valley Stadium

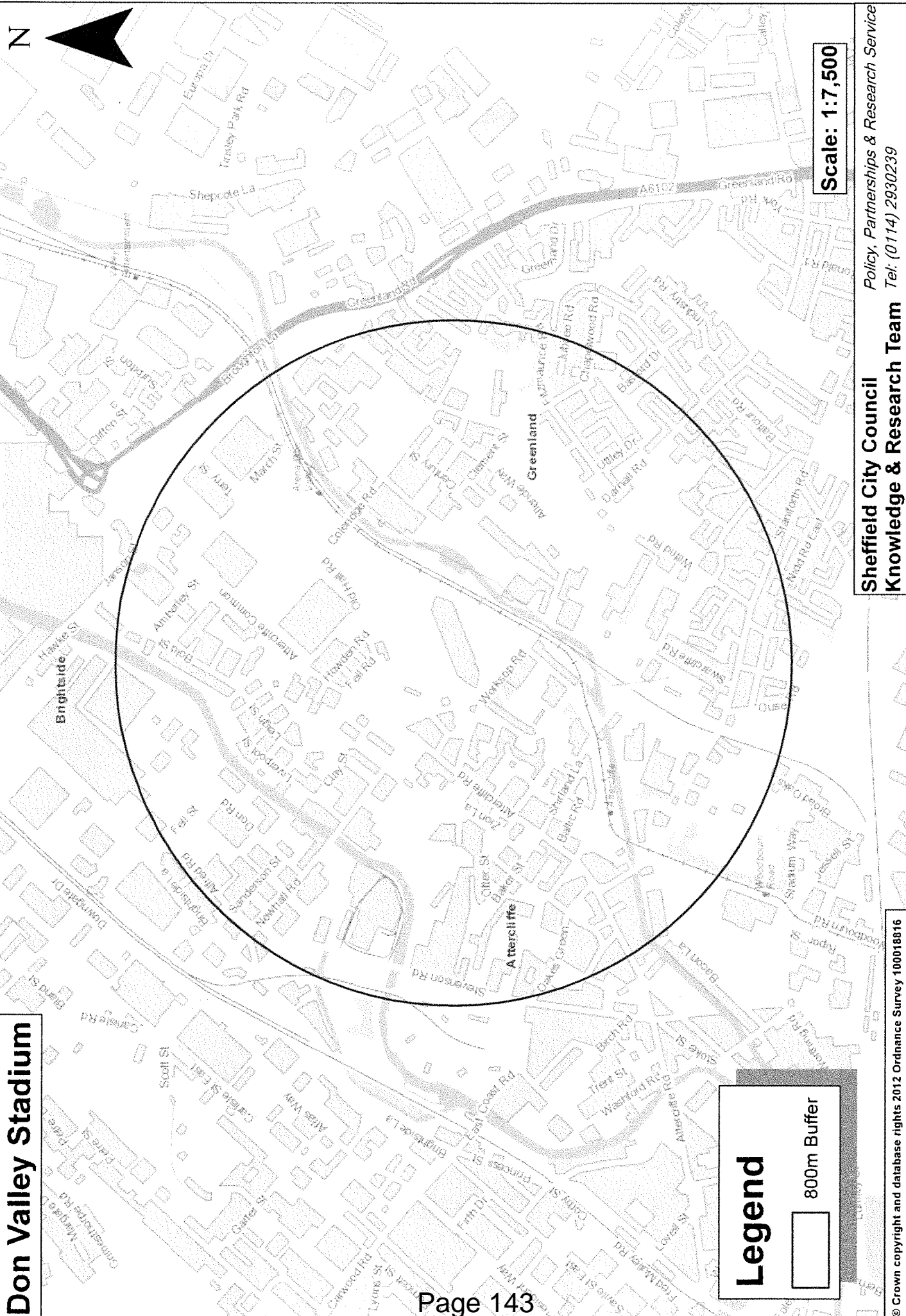

Scale: 1:7,500

Legend

800m Buffer

Sheffield City Council
Knowledge & Research Team
Policy, Partnerships & Research Service
Tel: (0114) 2930239

APPENDIX 14

**- PLAN AND RADIUS OF SHEFIELD MOTORPOINT
ARENA**

Sheffield Motorpoint Arena

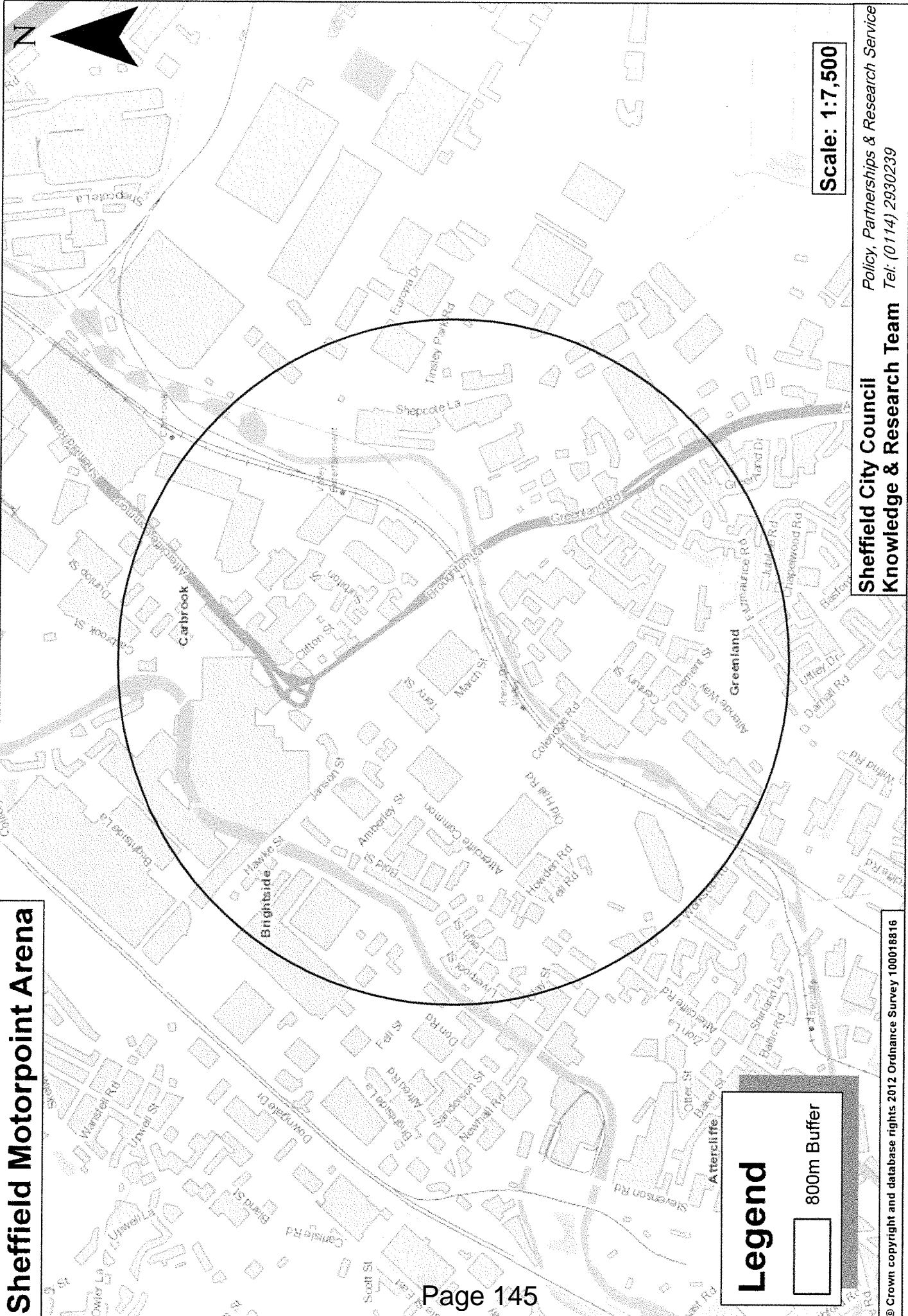

Scale: 1:7,500

Legend

800m Buffer

Sheffield City Council
Knowledge & Research Team
Policy, Partnerships & Research Service
Tel: (0114) 2930239

© Crown copyright and database rights 2012 Ordnance Survey 100018816

